Cyclotomic Matrices over Quadratic Integer Rings

Gary Greaves

Thesis submitted to the University of London
for the degree of Doctor of Philosophy

2012

Declaration of Authorship

I, Gary Greaves, hereby declare that this thesis and the work presented in it is entirely my own. Where I have consulted the work of others, this is always clearly stated.

Signed:

(Gary Greaves)

Date:

Summary

This thesis has been motivated largely by Lehmer's problem [20], which was stated in 1933 and it is still a problem that mathematicians have not completely solved. The Mersenne sequence, $(2^n - 1)_{n \in \mathbb{N}}$, has properties that make it useful for finding large primes but its terms become very large very fast. Lehmer's problem is related to finding large primes in sequences that are analogous to the Mersenne sequence but that grow as slowly as possible and Lehmer's conjecture implies a lower bound on the growth rate of any such sequence.

Lehmer's problem is usually stated in terms of a geometric constraint on the zeros of polynomials having integer coefficients and top coefficient 1. Breusch [4] and Smyth [38] have reduced the problem to one where it is only necessary to consider a much smaller class of polynomials. Some recent progress has been made on this restricted version of Lehmer's problem by associating some of the polynomials of this smaller class to combinatorial objects. The characteristic polynomial $\chi_A(x)$ of a matrix A is taken to be $\det(xI - A)$. For an $n \times n$ integer symmetric matrix A we define its **associated polynomial** as

$$R_A(z) := z^n \chi_A(z + 1/z).$$

A Hermitian matrix A is called **cyclotomic** if all of the zeros of R_A lie on the unit circle. McKee and Smyth [26] showed that Lehmer's conjecture holds for the polynomials R_A for all integer symmetric matrices A . Their method involved first classifying all cyclotomic integer symmetric matrices.

McKee [23] used the classification of cyclotomic integer symmetric matrices to classify certain polynomials (which he called **small-span** polynomials) that are also characteristic polynomials of integer symmetric matrices.

A large part of my research has involved developing the method of McKee and Smyth of associating algebraic numbers to combinatorial objects. The main results are the following.

1. The classification of cyclotomic matrices over the Eisenstein and Gaussian integers.
2. The classification of cyclotomic matrices over real quadratic integer rings.
3. Reducing to a finite search the proof that Lehmer's conjecture holds for polynomials R_A for all Hermitian matrices A over the Eisenstein and Gaussian integers.
4. Confirmation that Lehmer's conjecture holds for polynomials R_A for all real symmetric matrices A over real quadratic integer rings.
5. The classification of small-span polynomials that are also characteristic polynomials of Hermitian matrices over quadratic integer rings.

Acknowledgments

To my supervisor James McKee from whom I have learnt so much and whose patience, advice, and support have been invaluable to me. To the EPSRC and the Heilbronn institute for their funding which enabled me to go to various conferences and meetings. In particular, I found it very useful to discuss my research in Edinburgh with Chris Smyth and Graeme Taylor. To the mathematics department whose inhabitants, past and present, have created an open and friendly atmosphere. To Laurence for finding typos and to Anastasia, Ciaran, Kenny, Max, and Millie for musical interludes. To my friends for keeping me aware of life outside of the mathematics department. And finally, to my family for their love.

I extend my deepest gratitude.

Contents

1	Introduction	9
1.1	Boyd and Lehmer	9
1.2	Simple graphs	11
1.3	Integer symmetric matrices	13
1.4	Recurrent themes	15
2	Radical Integer Trees	19
2.1	Cyclotomics	19
2.2	Minimal non-cyclotomics	22
2.3	Coxeter systems	28
2.4	Unfolding trees	30
2.5	Boyd's conjecture	34
3	Hermitian Matrices over Imaginary Quadratic Integer Rings	40
3.1	Cyclotomic matrices over $\mathbb{Z}[i]$ and $\mathbb{Z}[\omega]$	40
3.2	Excluded subgraphs and Gram matrices	45
3.3	Proof of Theorem 3.1	48
3.4	Proof of Theorem 3.2	57
3.5	Proof of Theorem 3.3	62
3.6	The Eisenstein integers	69
3.7	Lehmer's problem	71
4	Hermitian Matrices over Real Quadratic Integer Rings	78
4.1	Integral characteristic polynomials	78
4.2	Classification of cyclotomic \mathcal{R} -matrices	79
4.3	Proof of Theorem 4.3	83
4.4	Applying Perron-Frobenius theory	89
4.5	Lehmer's problem	94
5	Small-Span Hermitian Matrices over Quadratic Integer Rings	102
5.1	Orientation	102
5.2	Computation of small-span matrices of up to 8 rows	103
5.3	Maximal small-span infinite families	113
5.4	Missing small-span polynomials	121
	Bibliography	123

List of Figures

1.1	Extended simply-laced Coxeter graphs	12
2.1	The maximal cyclotomic radical integer trees $\tilde{A}_1, \tilde{B}_n(n \geq 3), \tilde{C}_n(n \geq 2), \tilde{D}_n(n \geq 4), \tilde{E}_6, \tilde{E}_7, \tilde{E}_8, \tilde{F}_4,$ and \tilde{G}_2 . The numbers on the vertices correspond to eigenvectors with largest eigenvalue 2. The number of vertices is one more than the subscript.	21
2.2	The 9 minimal non-cyclotomic simple trees.	22
2.3	The minimal non-cyclotomic radical integer trees on more than 2 vertices with at least one irrational edge-weight.	23
2.4	Positive semidefinite Coxeter graphs. The number of vertices is one more than the subscript.	29
3.1	The families T_{2k} and $T_{2k}^{(x)}$ (respectively) of $2k$ -vertex maximal connected cyclotomic $\mathbb{Z}[x]$ -graphs, for $k \geq 3$ and $x \in \{i, \omega\}$. (The two copies of vertices A and B should be identified to give a toral tessellation.)	42
3.2	The family of $2k$ -vertex maximal connected cyclotomic $\mathbb{Z}[i]$ -graphs C_{2k} for $k \geq 2$	42
3.3	The families of $2k$ -vertex maximal connected cyclotomic \mathbb{Z} -graphs C_{2k}^{++} and C_{2k}^{+-} for $k \geq 2$	42
3.4	The family of $(2k+1)$ -vertex maximal connected cyclotomic $\mathbb{Z}[i]$ -graphs C_{2k+1} for $k \geq 1$	42
3.5	The sporadic maximal connected cyclotomic $\mathbb{Z}[\omega]$ -graphs $S_{10}, S_{12},$ and S_{14} of orders 10, 12, and 14 respectively. The \mathbb{Z} -graph S_{14} is also a $\mathbb{Z}[i]$ -graph.	43
3.6	The sporadic maximal connected cyclotomic \mathbb{Z} -hypercube S_{16}	43
3.7	The sporadic maximal connected cyclotomic $\mathbb{Z}[\omega]$ -graphs of orders 1, 2, 4, 5, and 6. The \mathbb{Z} -graphs S_1 and S_2 are also $\mathbb{Z}[i]$ -graphs.	43
3.8	The sporadic maximal connected cyclotomic $\mathbb{Z}[i]$ -graphs of orders 4, 7, and 8. The \mathbb{Z} -graphs $S_7, S_8,$ and S'_8 are also $\mathbb{Z}[\omega]$ -graphs.	43
3.9	some non-cyclotomic uncharged \mathbb{Z} -graphs.	48
3.10	some cyclotomic $\mathbb{Z}[i]$ -graphs that are contained as subgraphs of fixed maximal connected cyclotomic $\mathbb{Z}[i]$ -graphs.	48
3.11	some non-cyclotomic uncharged $\mathbb{Z}[i]$ -graphs.	58
3.12	some cyclotomic $\mathbb{Z}[i]$ -graphs that are contained as subgraphs of fixed maximal connected cyclotomic $\mathbb{Z}[i]$ -graphs.	58
3.13	some non-cyclotomic charged $\mathbb{Z}[i]$ -graphs.	63
3.14	some charged cyclotomic $\mathbb{Z}[i]$ -graphs that are contained as subgraphs of fixed maximal connected cyclotomic $\mathbb{Z}[i]$ -graphs.	63
3.15	some cyclotomic $\mathbb{Z}[\omega]$ -graphs that are contained as subgraphs of fixed maximal connected cyclotomic $\mathbb{Z}[\omega]$ -graphs.	69

List of Figures

3.16	some non-cyclotomic charged $\mathbb{Z}[\omega]$ -graphs.	71
3.17	some charged cyclotomic $\mathbb{Z}[\omega]$ -graphs that are contained as subgraphs of fixed maximal connected cyclotomic $\mathbb{Z}[\omega]$ -graphs.	71
3.18	Some $\mathbb{Z}[i]$ -graphs that are not subgraphs of any non-supersporadic graph having at least 5 vertices.	72
3.19	Some $\mathbb{Z}[i]$ -graphs that are <i>not</i> subgraphs of any non-supersporadic graph on at least 10 vertices.	75
4.1	The family T_{2k} of $2k$ -vertex maximal connected cyclotomic \mathbb{Z} -graphs, for $k \geq 3$. (The two copies of vertices A and B should be identified to give a toral tessellation.)	80
4.2	The family of $2k$ -vertex maximal connected cyclotomic $\mathbb{Z}[\sqrt{2}]$ -graphs C_{2k} for $k \geq 2$	80
4.3	The families of $2k$ -vertex maximal connected cyclotomic \mathbb{Z} -graphs C_{2k}^{++} and C_{2k}^{+-} for $k \geq 2$	80
4.4	The family of $(2k + 1)$ -vertex maximal connected cyclotomic $\mathbb{Z}[\sqrt{2}]$ -graphs C_{2k+1} for $k \geq 1$	80
4.5	The sporadic maximal connected cyclotomic \mathbb{Z} -graph S_{14} of order 14.	80
4.6	The sporadic maximal connected cyclotomic \mathbb{Z} -hypercube S_{16}	81
4.7	The sporadic maximal connected cyclotomic \mathcal{R} -graphs of orders 1, 2, 3 and 4.	81
4.8	The sporadic maximal connected cyclotomic \mathcal{R} -graphs of orders 6, 7, and 8.	81
4.9	some non-cyclotomic $\mathbb{Z}[\sqrt{2}]$ -graphs.	83
4.10	some cyclotomic $\mathbb{Z}[\sqrt{2}]$ -graphs that are contained as subgraphs of fixed maximal connected cyclotomic $\mathbb{Z}[\sqrt{2}]$ -graphs.	84
4.11	Four infinite families of nonnegative cyclotomic $\mathbb{Z}[\sqrt{2}]$ -graphs each having spectral radius 2. The numbers on the vertices correspond to an eigenvector with largest eigenvalue 2. The subscript is the number of vertices.	90
5.1	The infinite family \mathcal{T}_{2k} of $2k$ -vertex maximal connected cyclotomic templates. (The two copies of vertices A and B should be identified to give a toral tessellation.)	114
5.2	The infinite family of $2k$ -vertex maximal connected cyclotomic templates \mathcal{C}_{2k} and \mathcal{C}'_{2k} (respectively) for $k \geq 2$	115
5.3	The infinite family of $(2k + 1)$ -vertex maximal connected cyclotomic templates \mathcal{C}_{2k+1} for $k \geq 1$	115
5.4	Cyclotomic templates having span equal to 4. In the first three templates, the subscript denotes the number of vertices. The last template has $s + t + 1$ vertices and the two copies of the vertex A should be identified.	115
5.5	The \mathbb{Z} -graph $X_4^{(5)}$	116
5.6	The \mathbb{Z} -graphs $X_5^{(6)}$, $X_5^{(7)}$, $X_5^{(8)}$, $X_8^{(9)}$, $X_9^{(10)}$, $X_9^{(11)}$, $X_5^{(12)}$, and $X_5^{(13)}$ which all have span greater than or equal to 4.	120

List of Tables

3.1	Edge drawing convention for $\mathbb{Z}[i]$ -graphs.	41
3.2	Edge drawing convention for $\mathbb{Z}[\omega]$ -graphs.	41
3.3	Excluded subgraphs from Figure 3.10 and (up to equivalence) their containing maximal connected cyclotomic $\mathbb{Z}[i]$ -graphs.	49
3.4	Excluded subgraphs from Figure 3.12 and (up to equivalence) their containing maximal connected cyclotomic $\mathbb{Z}[i]$ -graphs.	58
3.5	Excluded subgraphs from Figure 3.14 and (up to equivalence) their containing maximal connected cyclotomic $\mathbb{Z}[i]$ -graphs.	63
3.6	Excluded subgraphs from Figure 3.15 and (up to equivalence) their containing maximal connected cyclotomic $\mathbb{Z}[\omega]$ -graphs.	69
3.7	Excluded subgraphs from Figure 3.17 and (up to equivalence) their containing maximal connected cyclotomic $\mathbb{Z}[\omega]$ -graphs.	71
4.1	Excluded subgraphs from Figure 4.10 and (up to equivalence) their containing maximal connected cyclotomic $\mathbb{Z}[\sqrt{2}]$ -graphs.	84
4.2	Up to equivalence, the number of elements of the set $\mathfrak{S}'_n \setminus \mathfrak{S}_n$ for $n \leq 6$	93
4.3	Lower bounds for the spectral radius and Mahler measure of non-cyclotomic matrices over real quadratic integer rings having at least one irrational entry.	101
5.1	The number of maximal small-span matrices, that are not equivalent to a \mathbb{Z} -matrix, of up to 8 rows for each d	112

Introduction

In this chapter we introduce the area of work with which this thesis is involved. We will begin by stating a couple of conjectures that provide the main motivation for the work in this thesis, and we give a partial survey of some results that supply us with a platform to build on. We will conclude the introductory chapter by stating some important material which will be used repeatedly throughout this thesis.

1.1 Boyd and Lehmer

A **Pisot number** is a real algebraic integer $\zeta > 1$ whose (Galois) conjugates have absolute value strictly less than 1. Somewhat trivial examples of Pisot numbers are the rational integers greater than 1. Pisot numbers have been well studied and much is known about them. In particular, Salem [32] proved that the set of Pisot numbers is closed and, shortly after, Siegel [35] showed that the smallest Pisot number ζ_0 is the real zero of the polynomial $x^3 - x - 1$. The set of Pisot numbers is denoted by \mathcal{S} . A related set of algebraic integers is the set \mathcal{T} of Salem numbers. A **Salem number** is a real algebraic integer $\tau > 1$ whose (Galois) conjugates have absolute value at most 1 with at least one having absolute value equal to 1. Much less is known about the set \mathcal{T} , for example it is not known whether there exists a smallest Salem number. It was shown, however, first by Salem [33], and then again later by Boyd [3], that each Pisot number is the limit (from both sides) of a sequence of Salem numbers. In his paper containing the proof of the above result, Boyd made the following conjecture.

Boyd's conjecture. *The set \mathcal{S} is the derived set of \mathcal{T} , and hence $\mathcal{S} \cup \mathcal{T}$ is closed.*

Let $f(x) = (x - \alpha_1) \cdots (x - \alpha_n)$ be a monic polynomial in $\mathbb{C}[x]$. The **Mahler measure** [22] $M(f)$ of f is defined to be the product of the absolute value of the zeros of f that lie outside of the unit circle; in symbols

$$M(f) = \prod_{j=1}^n \max(1, |\alpha_j|).$$

It is clear that the Mahler measure of a monic polynomial is at least 1. The Mahler measure $M(f)$ is 1 when f is a cyclotomic polynomial and when f is a monomial. By a theorem of Kronecker [19], we have the converse, that is, if $M(f) = 1$ then f is a product of cyclotomic polynomials and a monomial. In 1933, Lehmer [20] published a paper focused on the factorisation of elements in certain divisibility sequences. Given a monic integer polynomial f factorizing over \mathbb{C} as $f(x) = (x - \alpha_1) \cdots (x - \alpha_n)$, one can construct a divisibility sequence whose k th element is given by

$$\Delta_k(f) = \prod_{j=1}^n (\alpha_j^k - 1).$$

Notice that when $f(x) = x - 2$, the sequence $(\Delta_k(f))$ is the Mersenne sequence. Lehmer found that the elements of the sequences associated to polynomials with smaller Mahler measure grow slower, and hence those sequences are better for finding large primes. He posed the following problem.

Lehmer's problem. *If ε is a positive quantity, find a monic integer polynomial f such that the Mahler measure $M(f)$ lies between 1 and $1 + \varepsilon$.*

Along with this problem, Lehmer exhibited the following degree 10 polynomial

$$L(z) = z^{10} + z^9 - z^7 - z^6 - z^5 - z^4 - z^3 + z + 1,$$

which has Mahler measure $M(L) = \tau_0 = 1.1762808182599\dots$. To this day, L holds the world record for the smallest Mahler measure greater than 1 of an integer polynomial. Moreover, the larger real zero τ_0 of L is a Salem number and hence it is the smallest *known* Salem number (since every Salem number is the Mahler measure of its minimal polynomial). Although its attribution is dubious, the following conjecture is known as Lehmer's conjecture.

Lehmer's conjecture. *For monic $f(z) \in \mathbb{Z}[z]$, either $M(f) = 1$ or $M(f) \geq \tau_0$.*

For the history of Lehmer's problem see Smyth's expository article [37]. Note that both Boyd's conjecture and Lehmer's conjecture imply that there exists a smallest Salem number.

A polynomial f is called **reciprocal** if its coefficients are palindromic, i.e., f satisfies the equality

$$f(z) = z^{\deg f} f(1/z). \tag{1.1}$$

By a remarkable theorem of Smyth [38], if $f(z) \in \mathbb{Z}[z]$ is non-reciprocal then the Mahler measure of f is at least ζ_0 (the smallest Pisot number). A similar but weaker result was proved earlier by Breusch [4], Smyth's result, however, gives the best possible bound since the minimal polynomial of ζ_0 is non-reciprocal. Hence, to make progress with Lehmer's problem, one needs only to consider reciprocal polynomials.

Much of the work in this thesis is dedicated to studying Hermitian matrices over certain rings and, before we continue, we give a couple of important definitions. Define the **characteristic polynomial** of a matrix A by $\chi_A(x) = \det(xI - A)$. For an $n \times n$ matrix A , we define its **associated reciprocal polynomial** as

$$R_A(z) = z^n \chi_A(z + 1/z).$$

It is easy to see that $R_A(z)$ satisfies equation (1.1) and so it is indeed reciprocal. A Hermitian matrix A is called **cyclotomic** if its associated reciprocal polynomial R_A has integer coefficients and Mahler measure $M(R_A) = 1$. The name 'cyclotomic' is given because, by Kronecker's theorem (mentioned above), R_A is a product of cyclotomic polynomials and possibly a monomial. Let A be a Hermitian matrix such that its characteristic polynomial has integer coefficients. Then A is cyclotomic if and only if its eigenvalues are contained inside the interval $[-2, 2]$.

1.2 Simple graphs

Progress has been made on Boyd's conjecture and Lehmer's conjecture by associating algebraic integers to combinatorial objects. In this section we will state some of the results that have been obtained by studying simple graphs. A **simple graph** G is a graph having no loops nor any multiple edges. For most graph theorists, our 'simple graphs' are what they would simply call 'graphs', we deliberately use this longer phrase here since, in later sections, we will use the term 'graph' quite loosely.

Let G be a simple graph with adjacency matrix A . The characteristic polynomial χ_G of G is taken to be the characteristic polynomial χ_A of its adjacency matrix and the associated reciprocal polynomial R_G is defined as $R_G(z) := R_A(\sqrt{z})$ if G is bipartite and $R_G(z) := R_A(z)$ otherwise. The adjacency matrix A is a real symmetric matrix with all its entries from the set $\{0, 1\}$ and only zeros on the diagonal, its characteristic polynomial and associated reciprocal polynomial are both monic and both have integer coefficients. We call G **cyclotomic** if A is cyclotomic.

In 1970, Smith proved the following theorem.

Theorem 1.1. [36] *Let G be a connected cyclotomic simple graph. Then G is a subgraph of a simply-laced extended Coxeter graph.*

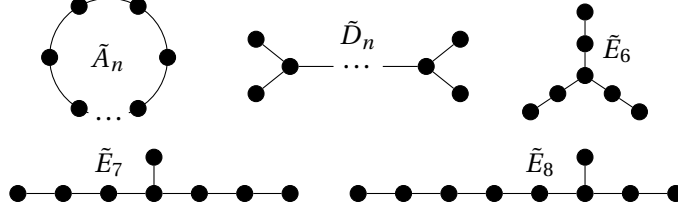

Figure 1.1: Extended simply-laced Coxeter graphs

Theorem 1.1 exposes an underlying connection between affine Coxeter groups and graphs G having $M(R_G) = 1$. We will explore this connection in more depth in the next chapter.

The next theorem classifies certain simple graphs with bounded spectra. And an immediate corollary confirms Lehmer's conjecture for polynomials associated to simple graphs. Hence one can also draw motivation for the work in this thesis from spectral graph theory.

Theorem 1.2. [9] *Let G be a non-cyclotomic simple graph such that all of its proper subgraphs are cyclotomic. Then G is one of the 18 graphs given in [9, Figure 3].*

Corollary 1.3. *Let G be a simple graph with adjacency matrix A .*

Then $M(R_A) = 1$ or $M(R_A) \geq \tau_0$.

One can associate Salem numbers and Pisot numbers to simple graphs, as was first done by McKee and Smyth [24]. We call a *nonbipartite* simple graph G a **Salem graph** if it has only one eigenvalue $\lambda > 2$ and no eigenvalues less than -2 . We call a *bipartite* simple graph G a **Salem graph** if it has only one eigenvalue $\lambda > 2$. Let G be a simple Salem graph with largest eigenvalue λ . If $\lambda^2 \notin \mathbb{Z}$ then G has a corresponding Salem number, that is, the largest zero of R_G . Define the set $\mathcal{T}_{\text{graph}}$ as the set of Salem numbers having a corresponding Salem graph.

Theorem 1.4. [24] *The set of limit points of $\mathcal{T}_{\text{graph}}$ is a subset of \mathcal{S} , which we will call $\mathcal{S}_{\text{graph}}$. Furthermore, $\mathcal{T}_{\text{graph}} \cup \mathcal{S}_{\text{graph}}$ is closed.*

The graph of a Pisot number in $\mathcal{S}_{\text{graph}}$ can be viewed as a bicoloured graph that encodes the limit of sequence of some Salem graphs, see [24, Section 8] for details. Theorem 1.4

settles Boyd's conjecture for Salem numbers and Pisot numbers that can be associated to simple graphs.

In Chapter 2, we settle Lehmer's conjecture and Boyd's conjecture for polynomials coming from certain weighted trees.

1.3 Integer symmetric matrices

Lehmer's problem has been settled for various classes of polynomials, for example Borwein et al. [1] showed that if f is a polynomial with odd coefficients then the Mahler measure of f is either 1 or at least $1.4953\dots$, which is strictly greater than τ_0 . And we have seen in the previous section that Lehmer's problem has been solved for polynomials R_G where G is a simple graph. Dobrowolski [10] showed that if R_A is irreducible for A an integer symmetric matrix then either $M(R_A) = 1$ or $M(R_A) \geq 1.043\dots$. Subsequently, McKee and Smyth confirmed Lehmer's conjecture for all polynomials R_A where A is an integer symmetric matrix.

Theorem 1.5. [26] *Let A be an integer symmetric matrix.*

Then $M(R_A) = 1$ or $M(R_A) \geq \tau_0$.

In order to obtain this result, McKee and Smyth [25] first classified cyclotomic integer symmetric matrices, that is, integer symmetric matrices A with $M(R_A) = 1$. Their approach to proving Theorem 1.5 takes advantage of a theorem of Cauchy which we will give in the next section. As was mentioned above, Lehmer's problem has been reduced, so that it suffices to consider only monic reciprocal integer polynomials, but we do not get all monic reciprocal integer polynomials from the associated reciprocal polynomial R_A of integer symmetric matrices A . Along with Theorem 1.5, McKee and Smyth gave a table of Mahler measures $M(R_A) < 1.3$ for A an integer symmetric matrix. Comparing this table with the table of small Salem numbers in [3, 28] exposes the Mahler measure $M(P) = 1.20261\dots$ as one that cannot be obtained at the Mahler measure of R_A for any integer symmetric matrix A . Here, P could be the polynomial

$$P(z) = z^{14} - z^{12} + z^7 - z^2 + 1.$$

This polynomial cannot be obtained from any integer symmetric matrix A (as R_A) since the polynomial $x^7 - 8x^5 + 19x^3 - 12x - 1$ is not the characteristic polynomial of any integer symmetric matrix. This degree 7 example and other small degree examples of polynomials

that are not the characteristic polynomial of any integer symmetric matrix were found by McKee [23] as low degree counterexamples to a conjecture of Estes and Guralnick, which we give below.

It is well established [11] that for every totally real algebraic integer α , there exists an integer symmetric matrix A having α as an eigenvalue, and hence the minimal polynomial of α divides χ_A . Furthermore, Hoffman [16] showed that this implies that every totally real algebraic integer is an eigenvalue of some adjacency matrix of a simple graph. Estes and Guralnick [12, page 84] conjectured that any monic separable totally real integer polynomial is the minimal polynomial of some integer symmetric matrix. This conjecture was shown to be false by Dobrowolski [10] who showed that if an irreducible polynomial f is the minimal polynomial of an integer symmetric matrix then the absolute value of its discriminant is at least $(\deg f)^{\deg f}$. And there exists an infinite family of irreducible polynomials f having discriminant less than $(\deg f)^{\deg f}$, the lowest degree of this family of polynomials is 2880. However, Estes and Guralnick proved their conjecture to be true for monic separable totally real integer polynomials of degree at most 4. In fact, what they proved is even stronger; they showed that for any monic separable totally real integer polynomial f of degree at most 4, there exists a $2n \times 2n$ integer symmetric matrix having f as its minimal polynomial. Since there exist reciprocal polynomials that are out of reach of integer symmetric matrices, in later chapters we consider Hermitian matrices over the ring of integers of quadratic extensions of the rationals.

At this point we confess that there exist reciprocal polynomials having small Mahler measure that are not equal to R_A for any Hermitian matrix A . Let f be a monic reciprocal integer polynomial with zeros $\alpha_1, \alpha_1^{-1}, \dots, \alpha_n, \alpha_n^{-1}$. A necessary condition for f to be realised as R_A for some Hermitian matrix A is for the polynomial

$$\tilde{f} = \prod_{j=1}^n (x - \alpha_j - \alpha_j^{-1})$$

to be totally real. But there exist reciprocal polynomials that do not satisfy this necessary condition, for example the polynomial

$$Q(z) = z^{18} + z^{17} + z^{16} - z^{13} - z^{11} - z^9 - z^7 - z^5 + z^2 + z + 1.$$

The polynomial \tilde{Q} is not totally real and hence Q cannot be realised as R_A for any Hermitian matrix A . The Mahler measure of Q is the fourth smallest known Mahler measure of monic integer polynomials, $M(Q) = 1.201396186235\dots$. Hence, to solve Lehmer's prob-

lem, it is not enough to consider only reciprocal polynomials R_A for Hermitian matrices A .

In Chapters 3 and 4, motivated by Lehmer's problem, we consider Hermitian matrices over imaginary quadratic integer rings and Hermitian matrices over real quadratic integer rings respectively. The last chapter is devoted to studying Hermitian matrices over quadratic integer rings whose eigenvalues are constrained in a slightly different way to those of cyclotomic matrices; these eigenvalues are subject only to the condition that the smallest and largest eigenvalue differ by less than 4. We complete this introductory chapter by giving some material, with which the subsequent chapters assume the reader is familiar.

1.4 Recurrent themes

We conclude this introductory chapter by giving some important definitions. Throughout this thesis we repeatedly use some ideas and results which we give in this section.

1.4.1 Equivalence and matrix visualisation

A major theme in this thesis is the use of weighted directed graphs as a convenient way of viewing Hermitian matrices. Let S be a subset of \mathbb{C} . For an element $x \in \mathbb{C}$ we write \bar{x} for the complex conjugate of x . An S -**graph** G is a directed weighted graph (G, w) whose weight function w maps pairs of vertices to elements of S and satisfies $w(u, v) = \overline{w(v, u)}$ for all vertices $u, v \in V(G)$. The adjacency matrix $A = (a_{uv})$ of G has $a_{uv} = w(u, v)$; this matrix depends on a 'labelling' of the vertices of G , which determines how the rows of A correspond to the vertices of G . For every vertex v , the **charge** of v is the number $w(v, v)$. A vertex with nonzero charge is called **charged**, those with zero charge are called **uncharged**. Notice that every Hermitian S -matrix can be recognised as the adjacency matrix of some S -graph.

Now we set up our notion of equivalence for Hermitian matrices over some subring $R \subseteq \mathbb{C}$. The philosophy of the following equivalence is to call two Hermitian R -matrices, A and B , equivalent if A is similar to $\pm B$ under some unitary transformation over R , which thus preserves the Mahler measure so that $M(R_A) = M(R_B)$.

We write $M_n(R)$ for the ring of $n \times n$ matrices over a ring $R \subseteq \mathbb{C}$. Let $U_n(R)$ denote the unitary group of matrices Q in $M_n(R)$ which satisfy $QQ^* = Q^*Q = I$, where Q^* denotes the Hermitian transpose of Q . Conjugation of a matrix $M \in M_n(R)$ by a matrix in $U_n(R)$

preserves the eigenvalues of M and the base ring R . Now, $U_n(R)$ has a subgroup $U'_n(R)$ generated by permutation matrices and diagonal matrices of the form

$$\text{diag}(1, \dots, 1, u, 1, \dots, 1),$$

where $u \in R$ has $|u| = 1$. Let D be such a diagonal matrix having u in the j th position. Conjugation by D is called a u -**switching** at vertex j . This has the effect of multiplying all the out-neighbour edge-weights of j by u and all the in-neighbour edge-weights of j by \bar{u} . The effect of conjugation by permutation matrices is just a relabelling of the vertices of the corresponding graph.

Let L be the Galois closure of the field generated by the elements of R over \mathbb{Q} . Denote by $\text{Gal}(L/\mathbb{Q})$ the Galois group of L over \mathbb{Q} . Let A and B be two matrices in $M_n(R)$. We say that A is **strongly equivalent over R** to B if $A = \sigma(QBQ^*)$ for some $Q \in U'_n(R)$ and some $\sigma \in \text{Gal}(L/\mathbb{Q})$, where σ is applied componentwise to the matrix QBQ^* . The matrices A and B are merely called **R -equivalent** if A is strongly equivalent over R to $\pm B$. When it is clear which ring R we are working over, we simply call matrices A and B **strongly equivalent** or **equivalent** if they are strongly equivalent over R or R -equivalent respectively. We are primarily interested in matrices with integer characteristic polynomials. Observe that, since they are rational integers, the coefficients of the characteristic polynomials of such matrices are invariant under Galois conjugation.

Let G be an S -graph with adjacency matrix A . By a **subgraph** H of G , we mean an induced subgraph; we say that G **contains** H and that G is a **supergraph** of H . The subgraphs of G correspond to the principal submatrices of A . Define the **underlying graph** of a Hermitian S -matrix A to be the corresponding S -graph of A whose charges are set to zero and whose other nonzero weights are set to 1; the underlying graph is a simple graph. The notions of a cycle/path/triangle etc. carry through in an obvious way from those of the underlying graph. By simply saying “ G is a graph,” we mean that G is a T -graph where T is some unspecified subset of the complex numbers. Note that all possible vertex-labellings of a graph are strongly equivalent over R for any subring $R \subset \mathbb{C}$. For this reason, we draw graphs without vertex labels.

We will find it useful to draw various graphs throughout this thesis and in each chapter we outline our drawing conventions which we will alter slightly from chapter to chapter. The changes in drawing conventions are there to simplify exposition and, even though they are not explicitly stated, hopefully the reasons for each slight change will be apparent.

1.4.2 Interlacing and matrix decomposition

We use repeatedly the following theorem of Cauchy [7, 13, 18] which we will sometimes refer to as ‘interlacing’.

Theorem 1.6 (Cauchy’s interlacing theorem). *Let A be an $n \times n$ Hermitian matrix with eigenvalues $\lambda_1 \leq \dots \leq \lambda_n$. Let B be an $(n - 1) \times (n - 1)$ principal submatrix of A with eigenvalues $\mu_1 \leq \dots \leq \mu_{n-1}$. Then the eigenvalues of A and B interlace. Namely,*

$$\lambda_1 \leq \mu_1 \leq \lambda_2 \leq \mu_2 \leq \dots \leq \mu_{n-1} \leq \lambda_n.$$

A matrix that is equivalent to a block diagonal matrix of more than one block is called **decomposable**, otherwise it is called **indecomposable**. A matrix is indecomposable if and only if its underlying graph is connected. The eigenvalues of a decomposable matrix are found by pooling together the eigenvalues of its blocks.

Let A be a Hermitian matrix and let B be a principal submatrix of A . By Theorem 1.6, we obtain an upper bound on the Mahler measure of R_B in terms of the Mahler measure of R_A , that is,

$$M(R_B) \leq M(R_A). \tag{1.2}$$

By equation (1.2), in order to settle Lehmer’s problem for the reciprocal polynomials R_A where A is some Hermitian matrix, it is sufficient to restrict our attention to Hermitian matrices that are minimal with respect to being non-cyclotomic. We call these matrices **minimal non-cyclotomic** matrices, they are the matrices A subject to the condition $M(R_A) > 1$ and $M(R_B) = 1$ for all proper principal submatrices B . We call an indecomposable cyclotomic matrix **maximal** if it is not contained as a proper submatrix of an indecomposable cyclotomic matrix.

Let G be an S -graph for some set $S \subseteq \mathbb{C}$. Define the **degree** of a vertex $v \in V(G)$ as

$$\sum_{u \in V(G)} |w(u, v)|^2.$$

The spectral radius $\rho(G)$ of G is defined as the maximum of the moduli of its eigenvalues.

Lemma 1.7. *Let G be a graph having spectral radius ρ . Then every vertex of G has degree at most ρ^2 .*

Proof. Suppose that v is a vertex of G having degree $d > \rho^2$ and let A be an adjacency matrix of G with v corresponding to the first row. The first entry of the first row of A^2 is

d . Therefore, by interlacing, the largest eigenvalue of A^2 is at least d , and so the spectral radius of A is at least $\sqrt{d} > \rho$, which is a contradiction. ■

Corollary 1.8. *Let G be a graph with a vertex v of degree $d > 4$. Then G is not cyclotomic.*

Radical Integer Trees

In this chapter, motivated by the combinatorial approach to Lehmer's problem and Boyd's conjecture, we study certain weighted trees. Define a **radical integer graph** to be an uncharged S -graph G where

$$S = \left\{ \sqrt{k} : k \in \mathbb{N}_0 \right\}.$$

By studying radical integer graphs we are effectively studying symmetric S -matrices. The **valency** of a vertex of v is defined to be the number of neighbours of v and we denote by $\Delta(G)$ the maximum valency of the vertices of G . We draw an edge-weight between two vertices u and v as $\bullet \overset{e}{-} \bullet$ if $e = w(u, v)$ is nonzero. If $w(u, v) = 1$ then, to reduce clutter, we simply draw $\bullet \text{---} \bullet$.

2.1 Cyclotomics

Building on the work of Smith [36] mentioned in the introduction, we classify the cyclotomic radical integer forests. We are interested in radical integer forests because of the following lemma.

Lemma 2.1. *Let T be a radical integer forest with adjacency matrix A . Then the characteristic polynomial $\chi_T := \chi_A$ has integer coefficients.*

Proof. We can assume that T is a tree since the characteristic polynomial of a forest is the product of the characteristic polynomials of its connected components. Let T_1 be a radical integer tree on a single vertex, it has characteristic polynomial $\chi_{T_1}(x) = x$ which is in $\mathbb{Z}[x]$. Let T_2 be a radical integer tree on two vertices with edge-weight $e_0 = \sqrt{k}$ ($k \in \mathbb{N}_0$), it has characteristic polynomial $\chi_{T_2}(x) = x^2 - e_0^2$ which is also in $\mathbb{Z}[x]$. Suppose T has $n > 2$ vertices and let u be a leaf vertex of T and let v be its neighbour with $w(u, v) = e$. Expanding the determinant $\chi_T(x)$ along the row corresponding to u gives

$$\chi_T(x) = x\chi_G(x) - e^2\chi_H(x)$$

where G is the induced subforest on $V(T) \setminus \{u\}$ and H is the induced subforest on $V(G) \setminus \{v\}$. Both G and H have fewer than n vertices and, since e^2 is an integer, the result follows by induction. \blacksquare

Let T be a radical integer tree with adjacency matrix A . Since A is a nonnegative matrix, we can appeal to the Perron-Frobenius theorem to study the eigenvalues of radical integer trees. Recall that the **spectral radius** $\rho(T)$ of T is defined as the maximum of the moduli of its eigenvalues.

Theorem 2.2. [14, Theorem 8.8.1] *Let T be a radical integer tree with adjacency matrix A .*

1. *The spectral radius $\rho := \rho(T)$ is a simple eigenvalue of T . If \mathbf{x} is an eigenvector for ρ then all the entries of \mathbf{x} are nonzero and have the same sign.*
2. *Suppose T' is a subforest of T . Then $\rho(T') < \rho(T)$.*
3. *Suppose T' is a radical integer forest with adjacency matrix A' such that $A - A'$ is nonnegative. Then $\rho(T') \leq \rho(T)$ with equality if and only if $A = A'$.*

For a Hermitian matrix, eigenvectors corresponding to distinct eigenvalues are orthogonal. Suppose that \mathbf{x} is an eigenvector of A with all entries positive. Then it cannot be orthogonal to a vector whose entries are all nonzero and of the same sign, and thus, by Theorem 2.2, it must be an eigenvector for the spectral radius ρ .

The classification of cyclotomic radical integer trees is almost a generalisation of Smith's [36] classification of cyclotomic simple graphs. It is not quite a generalisation since we are restricted to only considering forests.

Theorem 2.3. *Let T be a cyclotomic radical integer tree. Then T is contained in one of the maximal cyclotomic radical integer trees \tilde{A}_1 , $\tilde{B}_n (n \geq 3)$, $\tilde{C}_n (n \geq 2)$, $\tilde{D}_n (n \geq 4)$, \tilde{E}_6 , \tilde{E}_7 , \tilde{E}_8 , \tilde{F}_4 , and \tilde{G}_2 as in Figure 2.1.*

Proof. The numbers associated with the vertices of the radical integer trees in Figure 2.1 give the eigenvectors corresponding to the eigenvalue 2. By the remark following Theorem 2.2, since all entries of this eigenvector are positive, 2 is the largest eigenvalue. Moreover, by Theorem 2.2 these radical integer trees are maximal cyclotomic.

Conversely, let T be a radical integer tree whose spectral radius is at most 2. By Corollary 1.8, each vertex of T has degree at most 4 and hence each vertex has valency at most 4, that is, $\Delta(T) \leq 4$. Now we split into cases.

2. Radical Integer Trees

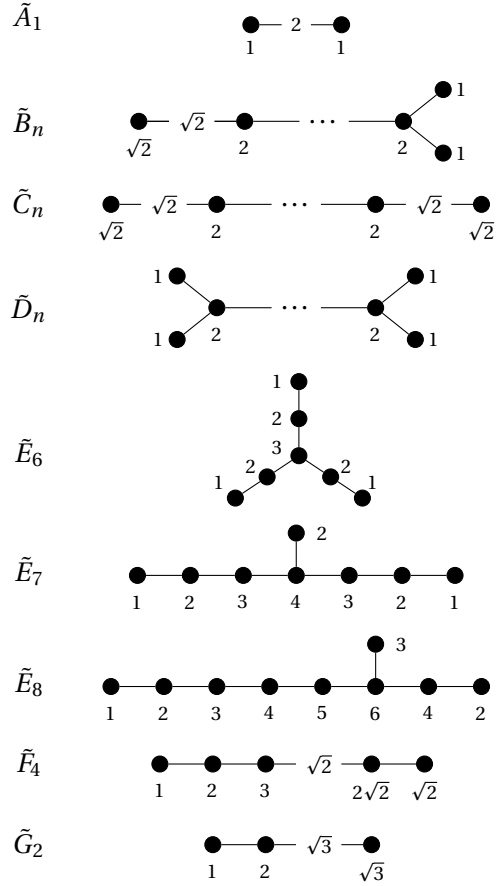

Figure 2.1: The maximal cyclotomic radical integer trees \tilde{A}_1 , $\tilde{B}_n(n \geq 3)$, $\tilde{C}_n(n \geq 2)$, $\tilde{D}_n(n \geq 4)$, \tilde{E}_6 , \tilde{E}_7 , \tilde{E}_8 , \tilde{F}_4 , and \tilde{G}_2 . The numbers on the vertices correspond to eigenvectors with largest eigenvalue 2. The number of vertices is one more than the subscript.

Case 1. $\Delta(T) = 4$. Suppose v is a vertex of T with valency 4, then every edge-weight incident to v is 1, otherwise the degree of v would exceed 4. In this case, then, T must contain \tilde{D}_4 , and since \tilde{D}_4 is maximal, we have that $T = \tilde{D}_4$.

Case 2. $\Delta(T) = 3$. Suppose v is a vertex of T with valency 3, then two of the edge-weights incident to v are 1 and the third incident edge-weight is either 1 or $\sqrt{2}$, otherwise the degree of v would exceed 4. If the third incident edge-weight is $\sqrt{2}$ then T must contain \tilde{B}_3 , so we assume the third incident edge-weight is 1. If another vertex of T has valency 3 then T must contain \tilde{D}_n for some n , otherwise, if T contained an edge-weight greater than 1 then T would properly contain either \tilde{G}_2 or \tilde{B}_n for some n . We thus assume that all other vertices of T have valency at most 2. Then, in order to avoid properly containing one of the maximal cyclotomic radical integer trees from Figure 2.1, T must be contained

in \tilde{B}_n , \tilde{E}_6 , \tilde{E}_7 , or \tilde{E}_8 .

Case 3. $\Delta(T) = 2$. In this case T must be a path. Again, in order to avoid proper containment of \tilde{C}_n , \tilde{F}_4 , or \tilde{G}_2 as subgraphs, T must be a subtree of one of the trees \tilde{C}_n , \tilde{F}_4 , or \tilde{G}_2 in Figure 2.1.

Case 4. $\Delta(T) = 1$. In this case it is easy to see that T must be a subtree of \tilde{A}_1 , \tilde{F}_4 , or \tilde{G}_2 . ■

This classification of cyclotomic radical integer trees strongly resembles the classification of irreducible root systems. We will address the resemblance in Section 2.3.

2.2 Minimal non-cyclotomics

A non-cyclotomic radical integer tree T is called **minimal non-cyclotomic** if every subforest of T is cyclotomic. In this section we classify the minimal non-cyclotomic radical integer trees.

As a part of their classification of minimal non-cyclotomic simple graphs (although neither did they call them such nor were trees treated separately) Cvetković et al. obtained the following result.

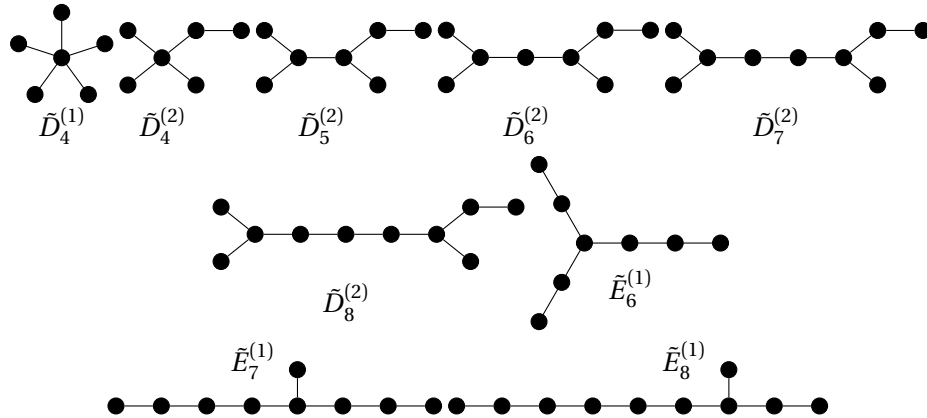

Figure 2.2: The 9 minimal non-cyclotomic simple trees.

Theorem 2.4. [8] *There are 9 minimal non-cyclotomic simple trees, $\tilde{D}_2^{(1)}$, $\tilde{D}_4^{(2)}$, $\tilde{D}_5^{(2)}$, $\tilde{D}_6^{(2)}$, $\tilde{D}_7^{(2)}$, $\tilde{D}_8^{(2)}$, $\tilde{E}_6^{(1)}$, $\tilde{E}_7^{(1)}$, and $\tilde{E}_8^{(1)}$ given in Figure 2.2.*

We will prove a generalisation of the above result, which we state below.

2. Radical Integer Trees

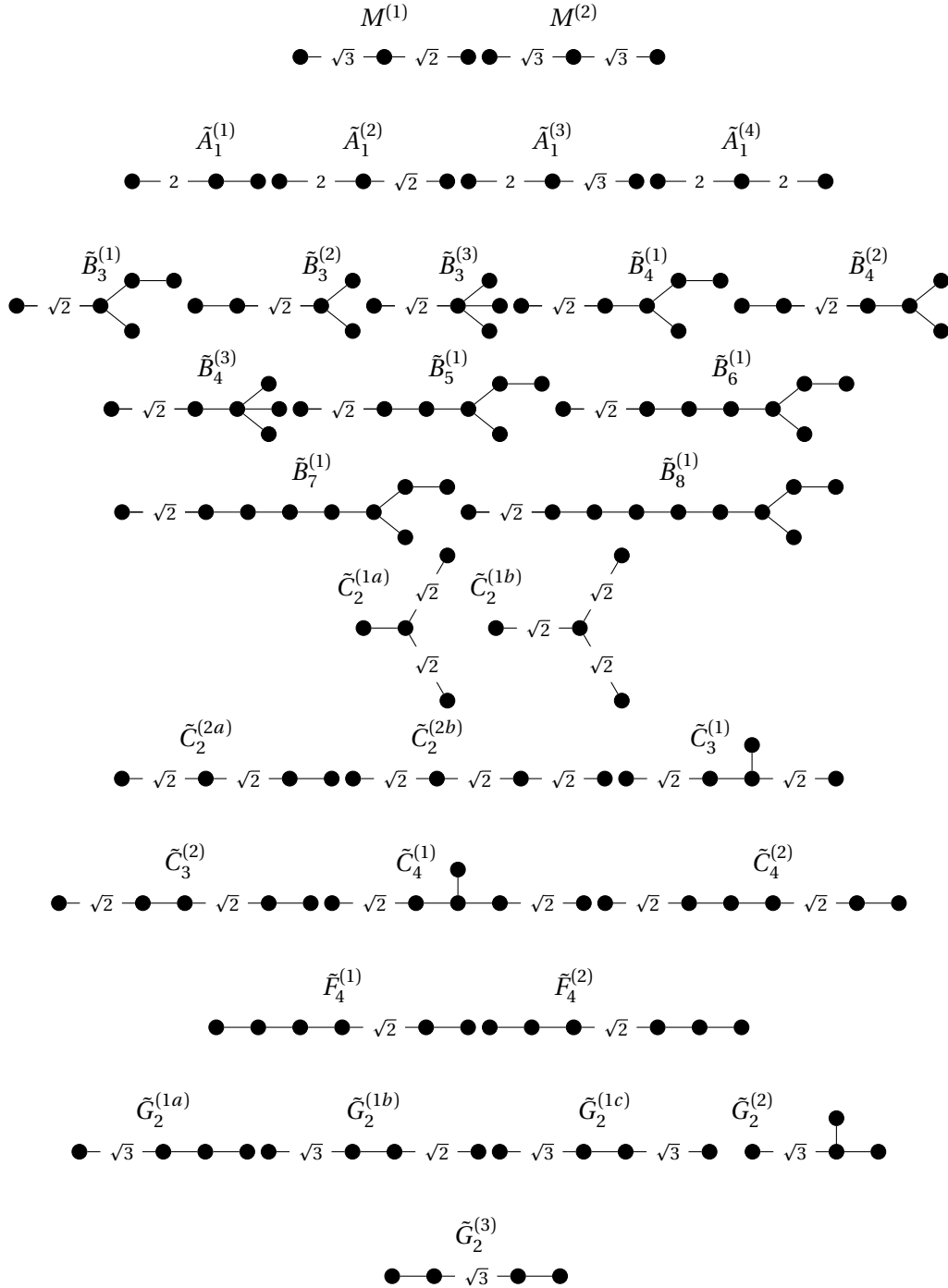

Figure 2.3: The minimal non-cyclotomic radical integer trees on more than 2 vertices with at least one irrational edge-weight.

Theorem 2.5. *Let T be a minimal non-cyclotomic radical integer tree. Then T is either an edge with weight \sqrt{a} for some $a > 4$ or one of the trees in Figures 2.2 and 2.3.*

The proof will require a collection of lemmata.

Lemma 2.6. *Let T be an edge of weight \sqrt{a} where $a \in \mathbb{N}$. Then T is minimal non-cyclotomic if and only if $a > 4$.*

Proof. The eigenvalues of T are $\pm\sqrt{a}$ and hence are contained inside the interval $[-2, 2]$ if and only if $a \leq 4$. Therefore T is non-cyclotomic if and only if $a > 4$. For minimality, observe that T cannot properly contain a non-cyclotomic tree. ■

Let T be a minimal non-cyclotomic radical integer tree on at least 3 vertices. The lemma above implies that the edge-weights of T are bounded above by 4.

Lemma 2.7. *Let T be a minimal non-cyclotomic radical integer tree on 3 vertices. Then T is one of $M^{(1)}$, $M^{(2)}$, $\tilde{A}_1^{(1)}$, $\tilde{A}_1^{(2)}$, $\tilde{A}_1^{(3)}$, or $\tilde{A}_1^{(4)}$.*

Proof. By Lemma 2.6, we can check this exhaustively (by hand). ■

Lemma 2.8. *Let T be a minimal non-cyclotomic radical integer tree containing a maximal cyclotomic radical integer tree M as a subgraph. Then the vertices of T are given by the set $V(M) \cup \{v\}$ where v is adjacent to exactly one vertex of M .*

Proof. Since T is non-cyclotomic, the containment of M must be proper. Moreover, by Theorem 2.2 and since the spectral radius of M is 2 (Theorem 2.3), any tree that properly contains M is non-cyclotomic. Now, T is minimal with respect to being non-cyclotomic and hence it must not contain any subforest that properly contains M . Therefore T can be obtained by attaching one vertex v to M , and since T is acyclic, v can only be adjacent to exactly one vertex of M . ■

Now, we consider minimal non-cyclotomic radical integer trees that contain various maximal cyclotomic radical integer trees. By the above lemma, we can think of such minimal non-cyclotomic trees as maximal cyclotomic trees with one extra vertex attached.

Lemma 2.9. *Let T be a minimal non-cyclotomic radical integer tree containing \tilde{A}_1 . Then T is either $\tilde{A}_1^{(1)}$, $\tilde{A}_1^{(2)}$, $\tilde{A}_1^{(3)}$, or $\tilde{A}_1^{(4)}$.*

Lemma 2.10. *Let T be a minimal non-cyclotomic radical integer tree containing \tilde{F}_4 . Then T is either $\tilde{B}_4^{(2)}$, $\tilde{C}_4^{(2)}$, $\tilde{F}_4^{(1)}$, or $\tilde{F}_4^{(2)}$.*

Lemma 2.11. *Let T be a minimal non-cyclotomic radical integer tree containing \tilde{G}_2 . Then T is either $\tilde{G}_2^{(1a)}$, $\tilde{G}_2^{(1b)}$, $\tilde{G}_2^{(1c)}$, $\tilde{G}_2^{(2)}$, or $\tilde{G}_2^{(3)}$.*

By Lemma 2.6 and Lemma 2.8, the proofs of Lemmata 2.9, 2.10, and, 2.11 come down to checking a small number of cases and we omit the details.

Lemma 2.12. *Let T be a minimal non-cyclotomic radical integer tree containing \tilde{B}_k for some k . Then T is either $\tilde{B}_3^{(1)}$, $\tilde{B}_3^{(2)}$, $\tilde{B}_3^{(3)}$, $\tilde{B}_4^{(1)}$, $\tilde{B}_4^{(2)}$, $\tilde{B}_4^{(3)}$, $\tilde{B}_5^{(1)}$, $\tilde{B}_6^{(1)}$, $\tilde{B}_7^{(1)}$, $\tilde{B}_8^{(1)}$, $\tilde{C}_3^{(1)}$, or $\tilde{C}_4^{(1)}$.*

Proof. By Lemma 2.8, we can assume that T is obtained by attaching a vertex v to a vertex of \tilde{B}_k with an edge of weight \sqrt{a} where, by Lemma 2.6, $a \in \{1, 2, 3, 4\}$. Suppose k is at least 9 and label the vertices of \tilde{B}_k by $v_1, \dots, v_{k-1}, x, y$ where v_j is adjacent to v_{j+1} for $j \in \{1, \dots, k-2\}$ and v_{k-1} is adjacent to both x and y . The edge between v_1 and v_2 has weight $w(v_1, v_2) = \sqrt{2}$. We split into three cases, where v is adjacent to vertices of valencies 1, 2, and 3.

Case 1. Suppose v is adjacent to a vertex of valency 1. Up to symmetry, we need only consider when v is adjacent to v_1 and when v is adjacent to x .

First, suppose v is adjacent to v_1 . Let T' be the subtree obtained by deleting vertex x from T . We can use Theorem 2.2 to compare the adjacency matrix of T' with the adjacency matrix of \tilde{F}_4 (adding extra zero rows/columns where necessary) to deduce that $\rho(T') > \rho(\tilde{F}_4) = 2$. This implies that T properly contains a non-cyclotomic subtree, which contradicts the minimality of T .

Secondly, suppose v is adjacent to x . Let T' be the subtree obtained by deleting vertex v_1 from T . We can use Theorem 2.2 to compare the adjacency matrix of T' with the adjacency matrix of \tilde{E}_8 (adding extra zero rows/columns where necessary) to deduce that $\rho(T') > \rho(\tilde{E}_8) = 2$. This implies, again, that T properly contains a non-cyclotomic subtree, which contradicts the minimality of T .

Case 2. Suppose v is adjacent to a vertex v_j of valency 2. We will use the same trick of comparing adjacency matrices and referring to the Perron-Frobenius Theorem. Let T' be the subtree obtained by deleting vertex x from T . Compare the adjacency matrix of T' with the adjacency matrix of \tilde{B}_{j+1} (adding extra zero rows/columns where necessary) to deduce that $\rho(T') > \rho(\tilde{B}_{j+1}) = 2$. This contradicts the minimality of T .

Case 3. Finally, suppose v is adjacent to the vertex v_{k-1} of valency 3. Let T' be the subtree obtained by deleting vertex v_1 from T . Compare the adjacency matrix of T' with the adjacency matrix of \tilde{D}_4 (adding extra zero rows/columns where necessary) to deduce that $\rho(T') > \rho(\tilde{D}_4) = 2$. This contradicts the minimality of T .

Therefore we need only consider T as a tree obtained by attaching a vertex to one of the vertices of the trees $\tilde{B}_3, \dots, \tilde{B}_8$. It remains to examine the possible ways of attaching a vertex to see the result; this is a small computation. ■

Lemma 2.13. *Let T be a minimal non-cyclotomic radical integer tree containing \tilde{C}_k for some k . Then T is either $\tilde{C}_2^{(1a)}$, $\tilde{C}_2^{(1b)}$, $\tilde{C}_2^{(2a)}$, $\tilde{C}_2^{(2b)}$, $\tilde{C}_3^{(1)}$, $\tilde{C}_3^{(2)}$, $\tilde{C}_4^{(1)}$, or $\tilde{C}_4^{(2)}$.*

Proof. By Lemma 2.8, we can assume that T is obtained by attaching a vertex v to a vertex of \tilde{C}_k with an edge of weight \sqrt{a} where $a \in \{1, 2, 3, 4\}$. Suppose k is at least 5 and label the vertices of \tilde{C}_k by v_1, \dots, v_{k+1} where v_j is adjacent to v_{j+1} for $j \in \{1, \dots, k\}$. Suppose v is adjacent to a vertex v_j of valency 2. If $j - 1 \leq k + 1 - j$ then set $l = j + 1$ and let T' be the subtree of T obtain by removing v_1 , otherwise set $l = k + 3 - j$ and let T' be the subtree of T obtain by removing v_{k+1} . We can use Theorem 2.2 to compare the adjacency matrix of T' with the adjacency matrix of \tilde{B}_l (adding extra zero rows/columns where necessary) to deduce that $\rho(T') > \rho(\tilde{B}_l) = 2$. Hence T properly contains a non-cyclotomic tree T' which contradicts the minimality of T .

Now suppose v is adjacent to a vertex of valency 1. Without loss of generality we can assume that v is adjacent to v_1 . Let T' be the subpath of T obtained by deleting the vertex v_{k+1} . Using Theorem 2.2 we can compare the adjacency matrix of T' with the adjacency matrix of \tilde{F}_4 (adding extra zero rows/columns where necessary) and deduce that $\rho(T') > \rho(\tilde{F}_4) = 2$. Hence, again, T properly contains a non-cyclotomic tree T' which contradicts the minimality of T . Therefore we need only consider T as a tree obtained by attaching a vertex to one of the vertices of the trees \tilde{C}_2, \tilde{C}_3 , and \tilde{C}_4 . It remains to examine the possible ways of attaching a vertex to see the result; this is a small computation. ■

Lemma 2.14. *Let T be a minimal non-cyclotomic radical integer tree on $n > 3$ vertices. Then T contains a maximal cyclotomic radical integer tree.*

Proof. The minimal non-cyclotomic simple trees have been classified in Theorem 2.4 and one can see by inspection that the theorem holds for these trees. We can henceforth assume that at least one edge-weight of T is greater than 1. Let $w > 1$ be the largest

edge-weight of T . The edge-weight w must be at most 2 otherwise T would properly contain a non-cyclotomic edge.

Case 1. $w = 2$. In this case it is clear that T contains \tilde{A}_1 .

Case 2. $w = \sqrt{3}$. Every proper subforest of T is cyclotomic. Let P be a 3-vertex subpath of T that contains an edge-weight $\sqrt{3}$. Since the degree of the valency 2 vertex of P is at most 4, the other edge-weight of P has to be 1. Hence T contains \tilde{G}_2 .

Case 3. $w = \sqrt{2}$. Let P be a subpath of T that has an edge-weight $\sqrt{2}$. If P has another edge-weight $\sqrt{2}$ then P (and hence T) contains \tilde{C}_k for some k . Otherwise, if P has only one edge-weight $\sqrt{2}$, either P properly contains \tilde{F}_4 or P is cyclotomic. If all subpaths are cyclotomic then, since T is non-cyclotomic, T must have a vertex of valency at least 3, in which case, T must contain \tilde{B}_k for some k . ■

From the proof above, in order to classify the minimal non-cyclotomic radical integer trees on at least 4 vertices it is only necessary to consider minimal non-cyclotomic radical integer trees that contain a maximal cyclotomic radical integer tree. Hence, together the lemmata above give a proof of Theorem 2.5.

Corollary 2.15. *Let T be a minimal non-cyclotomic radical integer tree. Then the second largest eigenvalue of T is less than 2.*

Proof. Let $\lambda_1 \leq \dots \leq \lambda_n$ be the eigenvalues of T . Let T' be obtained by deleting a vertex of T and let $\mu_1 \leq \dots \leq \mu_{n-1}$ be the eigenvalues of T' . Every proper subforest of T is cyclotomic and, in particular, $-2 \leq \mu_1$ and $\mu_{n-1} \leq 2$. By interlacing (Theorem 1.6), $\lambda_{n-1} \leq \mu_{n-1}$, and hence λ_{n-1} is at most 2. Suppose $\lambda_{n-1} = 2$, then the largest eigenvalue μ_{n-1} of T' must be 2. Therefore every subforest of T on $n - 1$ vertices must have a maximal cyclotomic radical integer tree as a component. By inspecting the minimal non-cyclotomic radical integer trees in Figure 2.3, it is easy to see that this is not the case. ■

To recapitulate, by Theorem 2.5 we have, for T a radical integer tree, either $M(R_T) = 1$ or $M(R_T) \geq \tau_0$. We have equality when T is $\tilde{E}_8^{(1)}$. This confirms Lehmer's conjecture for this restricted class of polynomials.

2.3 Coxeter systems

The classifications in the two previous sections resemble classifications from other areas of mathematics. A **Coxeter system** is a pair (W, S) consisting of a group W having presentation

$$W = \langle s \in S \mid (s's)^{m(s,s')} : (s, s') \in S' \subseteq S \times S \rangle,$$

where $m(s, s') = 1$ if $s = s'$ and $m(s, s') = m(s', s) \geq 2$ otherwise. The set S' is the set of pairs of generators (s, s') with $m(s, s')$ finite; for convention we write $m(s, s') = \infty$ for pairs of generators (s, s') not in S' . The group W is called a **Coxeter group**; W is determined up to isomorphism by the set of integers $m(s, s')$ for $s, s' \in S$. This information can be encoded in a graph Γ whose vertex set is S . Two vertices s and s' are adjacent if and only if $m(s, s') \geq 3$ and the edge between them is assigned the label $m(s, s')$. It is understood that $m(s, s') = 2$ for any non-adjacent pair of distinct vertices s and s' , and as a convention the label 3 is omitted. The graph we have described is called the **Coxeter graph** of W . We say a Coxeter system is **irreducible** if its Coxeter graph is connected.

We associate to a Coxeter graph Γ on n vertices an $n \times n$ symmetric matrix $B = (a_{jk})$ with entries

$$b_{jk} = -\cos\left(\frac{\pi}{m(j, k)}\right) \text{ for } j, k \in V(\Gamma). \quad (2.1)$$

Hence, we can associate a quadratic form $\mathbf{x}^\top B \mathbf{x}$ ($\mathbf{x} \in \mathbb{R}^n$) which is called **positive semidefinite** if all the eigenvalues of B are nonnegative and it is called **degenerate** if B has a zero eigenvalue.

Theorem 2.16. [2, Chapter VI, Theorem 4] *Let (W, S) be an irreducible Coxeter system with S finite. The associated quadratic form is positive semidefinite and degenerate if and only if the Coxeter graph is isomorphic to one of the graphs in Figure 2.4.*

Here we are abusing notation (by overloading the names of our graphs in Figure 2.1 and Figure 2.4), but we will try to justify this abuse by giving a relation between the quadratic forms of the graphs in Theorem 2.16 and the adjacency matrices of maximal cyclotomic radical integer trees. The above classification resembles two of the classifications we have seen earlier: Theorem 1.1 and Theorem 2.3. In fact, if we restrict to the simply-laced Coxeter graphs in Theorem 2.16 then we get precisely the maximal cyclotomic simple graphs in Theorem 1.1.

2. Radical Integer Trees

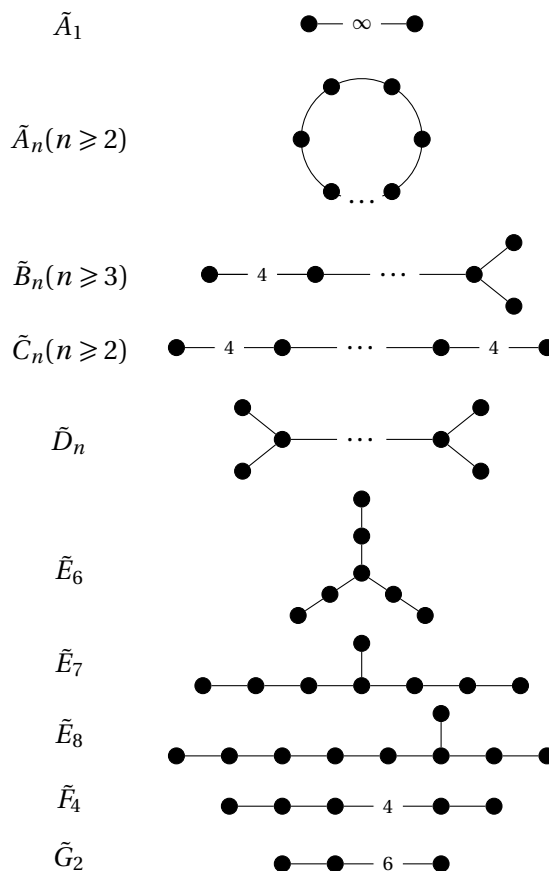

Figure 2.4: Positive semidefinite Coxeter graphs. The number of vertices is one more than the subscript.

Let T be a cyclotomic radical integer tree with adjacency matrix A . The eigenvalues of A are contained inside the interval $[-2, 2]$ and hence the matrix

$$B = I - \frac{1}{2}A \tag{2.2}$$

is positive semidefinite. Moreover, each diagonal entry of B is 1 and the remaining entries of B belong to the set

$$\frac{1}{2} \{0, -1, -\sqrt{2}, -\sqrt{3}, -2\}.$$

Each element of this set can be written as $-\cos(\pi/m)$ where m is in the set $\{2, 3, 4, 6, \infty\}$. Hence B is a matrix of a positive semidefinite quadratic form associated to some Coxeter system (W, S) with S finite. If T is a maximal cyclotomic radical integer tree then its largest eigenvalue is 2. Hence the matrix B is singular and its quadratic form corresponds to a Coxeter system with Coxeter graph isomorphic to one from Theorem 2.16. This also holds for \tilde{A}_n .

Let (W, S) be an irreducible Coxeter system, with graph Γ and associated quadratic form B . The Coxeter group W is called **hyperbolic** if the following two conditions are satisfied.

1. B is non-degenerate but not positive definite;
2. For each $s \in S$, the Coxeter graph obtained by removing s from Γ has a positive semidefinite quadratic form.

Let T be a minimal non-cyclotomic radical integer tree with adjacency matrix A and let $B = I - \frac{1}{2}A$. Since T is non-cyclotomic, it has an eigenvalue $\lambda > 2$ which corresponds to a negative eigenvalue of B making B not positive definite, and by Corollary 2.15, T does not have an eigenvalue equal to 2 which implies that B is non-degenerate. The second hyperbolic condition of B is satisfied since every proper subforest of T is cyclotomic. Therefore, every minimal non-cyclotomic radical integer tree corresponds to a Coxeter graph of a hyperbolic Coxeter group. This also holds for minimal non-cyclotomic simple graphs.

Lehmer's problem has been studied from the perspective of Coxeter groups; see the article of McMullen [27].

2.4 Unfolding trees

In this section we will show a connection between the spectra of radical integer graphs that are related by some kind of folding/unfolding action.

Proposition 2.17. *Let N be a radical integer graph with a distinguished vertex v . Let G be the graph obtained by attaching p leaf vertices to v so that the edge-weight between v and each leaf vertex is 1. Let H be the graph obtained (also from N) by attaching to v a single vertex with an edge of weight \sqrt{p} .*

Then G and H have the same nonzero spectrum and moreover the multiplicity of the zero-eigenvalue of G is $p - 1$ more than that of H .

Proof. Let A_N be the $n \times n$ adjacency matrix of N with the first row (and column) corresponding to v . Consider the adjacency matrices A_G and A_H of G and H respectively. Define $E_k = (e_{ij})$ to be an $k \times n$ matrix with

$$e_{ij} = \begin{cases} 1, & \text{if } j = 1; \\ 0, & \text{otherwise.} \end{cases}$$

2. Radical Integer Trees

Without loss of generality we can write the $(n+p) \times (n+p)$ matrix A_G and the $(n+1) \times (n+1)$ matrix A_H in the following way:

$$A_G = \begin{pmatrix} 0 & E_p \\ E_p^\top & A_N \end{pmatrix}; \quad A_H = \begin{pmatrix} 0 & \sqrt{p}E_1 \\ \sqrt{p}E_1^\top & A_N \end{pmatrix}.$$

Let the $(n+1) \times (n+p)$ matrix P be defined as

$$P = \begin{pmatrix} \frac{1}{\sqrt{p}} & \cdots & \frac{1}{\sqrt{p}} & 0 & \cdots & \cdots & 0 \\ 0 & \cdots & 0 & 1 & & & \vdots \\ \vdots & & & & \ddots & & \vdots \\ \vdots & & & & & \ddots & 0 \\ 0 & \cdots & \cdots & \cdots & \cdots & \cdots & 1 \end{pmatrix}.$$

$\underbrace{\hspace{10em}}_p \quad \underbrace{\hspace{10em}}_n$

We obtain the relationship

$$A_G = P^\top A_H P. \tag{2.3}$$

Hence

$$P^\top A_H P \mathbf{v}_k = \lambda_k \mathbf{v}_k,$$

where the \mathbf{v}_k ($1 \leq k \leq n+p$) are eigenvectors of A_G with corresponding eigenvalues λ_k .

We use the property $PP^\top = I_{(n+1)}$ to obtain

$$A_H P \mathbf{v}_k = \lambda_k P \mathbf{v}_k. \tag{2.4}$$

Therefore an eigenvector \mathbf{v}_k of A_G corresponds to an eigenvector $P\mathbf{v}_k$ of A_H if and only if it is not in the kernel of P . Pick a basis $\mathbf{v}_1, \dots, \mathbf{v}_{p-1}$ for $\ker P$. By equation (2.3), each \mathbf{v}_k ($1 \leq k \leq p-1$) is in the zero eigenspace of G . Using eigenvectors of G , we can extend to a basis for \mathbb{R}^{n+p} given by the vectors

$$\mathbf{v}_1, \dots, \mathbf{v}_{p-1}, \mathbf{v}_p, \dots, \mathbf{v}_{n+p}.$$

Apply P to each of these vectors. The proof of rank-nullity gives $P\mathbf{v}_p, \dots, P\mathbf{v}_{n+p}$ as a basis for $\text{im } P = \mathbb{R}^{n+1}$. Since the relevant $P\mathbf{v}_k$ are not zero, by equation (2.4), we have that the vectors $P\mathbf{v}_p, \dots, P\mathbf{v}_{n+p}$ are eigenvectors for A_H with corresponding eigenvalues $\lambda_p, \dots, \lambda_{n+p}$. (These eigenvalues are precisely those of $\mathbf{v}_p, \dots, \mathbf{v}_{n+p}$ for A_G .) Moreover, since the eigenvectors $P\mathbf{v}_p, \dots, P\mathbf{v}_{n+p}$ are linearly independent, G and H have the same nonzero spectrum. The $p-1$ eigenvectors in the zero-eigenspace of G in $\ker P$ do not correspond to eigenvectors of H , and hence we have the result. ■

Now, instead of just vertices, consider attaching graphs to a vertex.

Proposition 2.18. *Let N be a radical integer graph with distinguished vertex v_N and let L be a radical integer graph with distinguished vertex v_L . Let G be the graph obtained by attaching p copies of L to N with an edge of weight 1 between v_N and each v_L . Let H be the graph obtained by attaching a single copy of L to N with an edge of weight \sqrt{p} between v_N and v_L .*

Then the spectrum of H is a sub-list of the spectrum of G and moreover G and H have the same spectral radius, i.e., $\rho(G) = \rho(H)$.

Proof. Let A_N be the $n \times n$ adjacency matrix of N with the first row corresponding to v_N and let A_L be the $m \times m$ adjacency matrix of L with the first row corresponding to v_L . Consider the adjacency matrices A_G and A_H of G and H respectively. Define $E = (e_{ij})$ to be the $n \times m$ matrix with the entry $e_{11} = 1$ and all other entries equal to 0. Without loss of generality we can write the $(n + mp) \times (n + mp)$ matrix A_G and the $(n + m) \times (n + m)$ matrix A_H in the following way:

$$A_G = \begin{pmatrix} A_N & E & \dots & E \\ E^\top & A_L & & \\ \vdots & & \ddots & \\ E^\top & & & A_L \end{pmatrix}; \quad A_H = \begin{pmatrix} A_N & \sqrt{p}E \\ \sqrt{p}E^\top & A_L \end{pmatrix}.$$

Let the $(n + m) \times (n + pm)$ matrices C_k , for $k \in \{1, \dots, p\}$, be defined as

$$C_k = \begin{pmatrix} \frac{1}{\sqrt{p}}I_n & 0 & 0 & \dots & 0 \\ 0 & \delta_{1k}I_m & \delta_{2k}I_m & \dots & \delta_{pk}I_m \end{pmatrix},$$

where δ_{ij} is the Kronecker delta. Multiplying A_H on the right by C_k and on the left by C_k^\top gives

$$C_k^\top A_H C_k = \begin{pmatrix} \frac{1}{p}A_N & \delta_{1k}E & \dots & \delta_{pk}E \\ \delta_{1k}E^\top & \delta_{1k}A_L & & \\ \vdots & & \ddots & \\ \delta_{pk}E^\top & & & \delta_{pk}A_L \end{pmatrix}.$$

Thus, we obtain the relationship

$$A_G = \sum_{k=1}^p C_k^\top A_H C_k.$$

Hence

$$\left(\sum_{k=1}^p C_k^\top A_H C_k\right) \mathbf{v}_k = \lambda_k \mathbf{v}_k,$$

where the \mathbf{v}_k ($1 \leq k \leq n + mp$) are eigenvectors of A_G with corresponding eigenvalues λ_k .

We use the property

$$\left(\sum_{k=1}^p C_k\right) C_l^\top = I_{(n+m)} \quad \forall l \in \{1, \dots, p\}$$

to obtain

$$A_H \left(\sum_{k=1}^p C_k\right) \mathbf{v}_k = \lambda_k \left(\sum_{k=1}^p C_k\right) \mathbf{v}_k. \quad (2.5)$$

Set $P = \sum_{k=1}^p C_k$. An eigenvector \mathbf{v}_k of A_G corresponds to an eigenvector $P\mathbf{v}_k$ of A_H if and only if it is not in the kernel of P . Let B be a set of eigenvectors of A_G that form a basis for \mathbb{R}^{n+mp} given by

$$B = \{\mathbf{v}_1, \dots, \mathbf{v}_{m(p-1)}, \mathbf{v}_{m(p-1)+1}, \dots, \mathbf{v}_{n+mp}\},$$

where the vectors $\mathbf{v}_1, \dots, \mathbf{v}_{m(p-1)}$ lie in $\ker P$. The vectors of the set

$$B' = \{P\mathbf{v} : \mathbf{v} \in B \setminus (B \cap \ker P)\}$$

form a basis for $\text{im } P = \mathbb{R}^{n+m}$ and hence, each eigenvalue of H is an eigenvalue of G . (In contrast with Proposition 2.17 - all A_G -eigenvectors forming a basis for P were in the zero eigenspace of A_G , with $A_G : \ker P \rightarrow \{0\}$ whereas since $PA_G = A_HP$, we have only that $A_G : \ker P \rightarrow \ker P$.)

Let \mathbf{w} be an eigenvector of G corresponding the eigenvalue $\rho(G)$. By Theorem 2.2, we can assume that all entries of \mathbf{w} are positive. Since the transformation matrix P has only nonnegative entries, \mathbf{w} cannot be in $\ker P$ and hence we can choose B so that $P\mathbf{w}$ is in B' . Moreover, $P\mathbf{w}$ has all entries positive and hence, by Theorem 2.2, it corresponds to $\rho(H)$. Therefore, \mathbf{w} and $P\mathbf{w}$ correspond to the same eigenvalue $\rho(G) = \rho(H)$. ■

Corollary 2.19. *Let T be a radical integer tree with spectrum $\lambda(T)$. Then there exists a simple tree T' whose spectrum contains $\lambda(T)$ and whose spectral radius $\rho(T') = \rho(T)$.*

Proof. We can repeatedly apply Proposition 2.18 to T , effectively replacing edge-weights \sqrt{p} (for some $p \in \mathbb{N}$) by p edges of weight 1, until we obtain the simple tree T' whose spectrum contains $\lambda(T)$ and whose spectral radius $\rho(T') = \rho(T)$. ■

In the next section we will briefly mention replacing an edge of weight \sqrt{k} with k edges of weight 1 in the way described in the results above. We will refer to this replacement as ‘unfolding’.

2.5 Boyd's conjecture

We call a radical integer forest a **Salem forest** if it has only one eigenvalue $\lambda > 2$. Recall that, to each Hermitian matrix, we associate a reciprocal polynomial $R_A(z)$. Let T be an n -vertex Salem forest with adjacency matrix A . Now, since T is bipartite, if λ is an eigenvalue of T then so too is $-\lambda$, and hence each monomial of χ_T has an even power, i.e., $\chi_T(x) = p(x^2)$ for some monic integer polynomial p . We therefore associate to T the reciprocal polynomial defined as follows

$$R_T(z) := R_A(\sqrt{z}) = z^{n/2} \chi_A(\sqrt{z} + 1/\sqrt{z}).$$

If $\rho(T) \in \mathbb{Z}$ then T is called a **trivial** Salem forest, otherwise it is called a **nontrivial** Salem forest. The Salem number $\tau(T)$ associated to a nontrivial Salem forest T is the larger root of the equation $\sqrt{z} + 1/\sqrt{z} = \rho(T)$.

Proposition 2.20. *Let T be a Salem forest. Then every subforest of T has at most one non-cyclotomic connected component.*

Proof. Suppose that T contains a subforest T' having at least 2 non-cyclotomic connected components. Then T' has at least 2 eigenvalues greater than 2 and hence, by Theorem 1.6, so does T . This is a contradiction. ■

Proposition 2.21. *Let T be a non-cyclotomic radical integer forest having a vertex v such that the induced subforest on $V(T) \setminus \{v\}$ is cyclotomic. Then T is a Salem forest.*

Proof. By Theorem 1.6, the second largest eigenvalue of T is bounded above by the largest eigenvalue of any induced subgraph of T on $|V(T)| - 1$ vertices. Since one can obtain a cyclotomic subforest by deleting a single vertex v , the second largest eigenvalue of T is at most 2. ■

The converse of this proposition is not true. For example, the following radical integer tree T is a Salem tree such that none of its subforests obtained by deleting a single vertex is cyclotomic.



By ‘unfolding’ this tree we can obtain the following simple Salem tree T_1 .

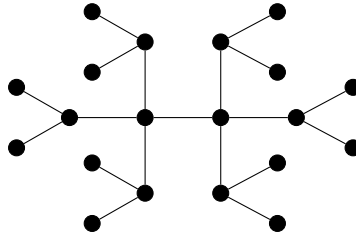

By Proposition 2.18 the spectrum of T_1 contains the spectrum of T and $\rho(T) = \rho(T_1)$. This might give one hope that, for every Salem tree T there exists a simple Salem tree T' with $\rho(T) = \rho(T')$; thereby reducing the proof of Boyd’s conjecture for Salem numbers associated to Salem trees to that of simple Salem trees. If it is the case that one can restrict to considering only simple Salem trees, then, if working via ‘unfolding’, one needs to be careful of how one ‘unfolds’. To demonstrate this, by ‘unfolding’ T in a different way, one can obtain the radical integer tree T_2 :

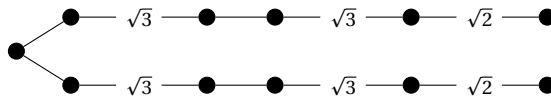

The tree T_2 is not Salem; this can be seen by using Proposition 2.20: delete the leftmost vertex in the picture above to give a subforest consisting of two non-cyclotomic connected components. Hence, by Proposition 2.18, any further ‘unfolding’ of T_2 will also not be Salem. Therefore we cannot simply reduce the study of Salem trees to the study of simple Salem trees via ‘unfolding’ in this way.

Recall Boyd’s conjecture [3], that the set of Pisot numbers \mathcal{S} is the set of limit points of the set of Salem numbers \mathcal{T} . McKee and Smyth [24, Theorem 1.1] settled a version of Boyd’s conjecture for Salem and Pisot number coming from simple graphs. In order to obtain this result, McKee and Smyth used a series of lemmata. Almost all of the lemmata used do not depend on the edge-weights of the graphs and can therefore be automatically extended to hold for radical integer trees. For the convenience of the reader we repeat these lemmata.

Let T be a Salem tree with spectral radius ρ . The following lemma gives upper bounds (in terms of ρ) on the number of vertices of T having degree not equal to 2. Furthermore, it bounds the number of vertices of T of valency 1, which means only the number of vertices with both degree 2 and valency 2 is unbounded.

Lemma 2.22. *Let T be a Salem tree with spectral radius $\rho := \rho(T)$. Then*

- (i) *The vertices $V(T)$ of T can be partitioned as $V(T) = M \cup A \cup H$, in such a way that*
- *the induced subtree $T|_M$ is one of the minimal non-cyclotomic radical integer trees from Theorem 2.5;*
 - *the set A consists of all vertices of $V(T) \setminus M$ adjacent in T to some vertex in M ;*
 - *the induced subforest $T|_H$ is cyclotomic.*
- (ii) *T has at most $B := 10(3\rho^4 + \rho^2 + 1)$ vertices of degree greater than 2, and at most $\rho^2 B$ vertices of valency 1.*

The proof is almost exactly the same as the proof of Proposition 3.2 in [24].

Proof. Since it is non-cyclotomic, T must contain a minimal non-cyclotomic radical integer tree $T|_M$ as in Theorem 2.5 and $T|_M$ can have at most 10 vertices. Define A to be the subset of vertices of $V(T) \setminus M$ having a neighbour in M . By Proposition 2.20, the subforest T' on $V(T) \setminus A$ has at most 1 (in fact precisely 1) eigenvalue greater than 2, which must be the spectral radius of $T|_M$. Therefore, the other connected components of T' form a cyclotomic forest which we define to be $T|_H$.

By Lemma 1.7, the degree of each vertex is bounded by ρ^2 . We can apply this to the vertices in M to obtain a crude bound on the cardinality of the neighbouring set A , that is, $|A| \leq 10\rho^2$. Applying this argument to the vertices in A adjacent to some vertices in H , we have that there are at most $\rho^2|A|$ edges with one endvertex in A and the other in H . Now, every connected cyclotomic radical integer tree has at most 2 vertices of degree greater than 2, see Figure 2.1. Since T is connected, each connected component of $T|_H$ must have an edge going from it to a vertex in A . Hence there are at most another $2\rho^2|A|$ vertices of degree greater than 2 in H . Summing up gives a bound of at most $|M| + |A| + \rho^2|A| + 2\rho^2|A| \leq 10(3\rho^4 + \rho^2 + 1)$ vertices of degree greater than 2 in T .

To bound the number of vertices of valency 1, we simply associate each such vertex with the nearest (as in number of hops) vertex of degree greater than 2, and then use the degree bound of ρ^2 (from Lemma 1.7) on these latter vertices. ■

An edge is called **pendant** if at least one of its incident vertices has valency 1, otherwise it is called **internal**. Similarly, a path is called **pendant** if it contains at least one pendant edge, otherwise it is called **internal**.

Lemma 2.23. [24, Lemma 4.2] Let T be a radical integer forest and (v_1, v_2, \dots, v_k) a list of (not necessarily distinct) vertices of T . Let $T_{(m_1, \dots, m_k)}$ be the radical integer forest obtained by attaching one endvertex of an m_i -vertex simple path to vertex v_i (so $T_{(m_1, \dots, m_k)}$ has $m_1 + \dots + m_k$ more vertices than T).

Let $R_{m_1, \dots, m_k}(z)$ be the reciprocal polynomial of $T_{(m_1, \dots, m_k)}$. Then if all the m_i are at least 2 we have

$$(z-1)^k R_{m_1, \dots, m_k}(z) = \sum_{\varepsilon_1, \dots, \varepsilon_k \in \{0,1\}} z^{\sum \varepsilon_i m_i} P_{(\varepsilon_1, \dots, \varepsilon_k)}(z),$$

for some integer polynomials $P_{(\varepsilon_1, \dots, \varepsilon_k)}(z)$ that depend on T and (v_1, \dots, v_k) but not on m_1, \dots, m_k .

With notation as in Lemma 2.23, we refer to $P_{(1, \dots, 1)}$ as the **leading polynomial** of R_{m_1, \dots, m_k} .

Corollary 2.24. [24, Corollary 4.4] With notation as in Lemma 2.23, suppose further that T is a radical integer tree and that $T_{(m_1, \dots, m_k)}$ is a Salem tree for all sufficiently large m_1, \dots, m_k . Then $T_{(m_1, \dots, m_k)}$ is a nontrivial Salem tree for all but finitely many (m_1, \dots, m_k) .

Furthermore, $P_{(1,1, \dots, 1)}(z)$, the leading polynomial of $R_{m_1, \dots, m_k}(z)$, is the product of the minimal polynomial of some Pisot number (ζ , say), a power of z , and perhaps some cyclotomic polynomials.

Moreover, if we let all the m_i tend to infinity in any manner (one at a time, in bunches, or all together, perhaps at varying rates), the Salem numbers $\tau_{m_1, \dots, m_k} := \tau(T_{(m_1, \dots, m_k)})$ tend to ζ .

Lemma 2.25. [24, Lemma 4.5] Let T be a radical integer forest with two distinguished vertices v_1 and v_2 . Let $T^{(m_1, m_2)}$ be the radical integer forest obtained by identifying the endvertices of an $(m_1 + m_2 + 3)$ -vertex simple path with vertices v_1 and v_2 (so that $T^{(m_1, m_2)}$ has $m_1 + m_2 + 1$ more vertices than T).

Let $R^{(m_1, m_2)}$ be the reciprocal polynomial of $T^{(m_1, m_2)}$. Then

$$R^{(m_1, m_2)}(z) = (z-1)R_{m_1, m_2}(z) + Q_{m_1, m_2}(z),$$

where Q_{m_1, m_2} has much smaller degree compared to R_{m_1, m_2} , in the sense that

$$\deg R_{m_1, m_2} - \deg Q_{m_1, m_2} \rightarrow \infty$$

as $\min(m_1, m_2) \rightarrow \infty$.

Let \mathcal{T}' be the set of Salem numbers $\tau(T)$ such that T is a nontrivial Salem forest.

Theorem 2.26. *The set of limit points of \mathcal{T}' is some subset S' of Pisot numbers. Furthermore, $\mathcal{T}' \cup S'$ is closed.*

The proof is a small modification of the proof of Theorem 1.4 in [24, Theorem 1.1].

Proof. Consider an infinite sequence (S_r) of nontrivial Salem forests such that the corresponding sequence of Salem numbers $(\tau(S_r))$ is convergent. The connected components of a Salem forest consist of exactly one Salem tree and perhaps some cyclotomic radical integer trees. Since the cyclotomic components have no effect on the corresponding Salem number, we can assume that (S_r) is a sequence of nontrivial Salem trees. We would like to know about the limit points of \mathcal{T}' and hence, by means of moving to a subsequence, we may assume that (S_r) does not contain a constant subsequence. Since the sequence of Salem numbers converges, each Salem number in this sequence is bounded. By Lemma 2.22, we have an upper bound on the number of vertices of degree greater than 2 and the number of vertices of valency 1. Furthermore, Lemma 1.7 gives an upper bound for the degree of each vertex.

Let \mathfrak{S} be the set of radical integer trees with at most B_1 vertices each of which has degree at most B_2 and no vertices having both degree 2 and valency 2. Then the set \mathfrak{S} is finite and each Salem tree T of (S_r) can be associated with an element of \mathfrak{S} having T as a subdivision of some of its edges. Now, since \mathfrak{S} is finite, there are only finitely many radical integer trees in \mathfrak{S} that are associated to elements of (S_r) . By moving to a subsequence, we can assume that all the Salem trees of (S_r) are associated to the same radical integer tree $M \in \mathfrak{S}$. Label the edges of M by e_1, \dots, e_m . Each e_j corresponds to a simple path of length $l_{j,n}$ joining the two vertices incident to e_j , in the n th Salem tree of (S_r) .

Consider the sequence $(l_{1,n})$. If it is bounded then it has an infinite constant subsequence, else it has a subsequence monotonically tending to infinity. Hence, by means of taking a suitable subsequence, we can assume that $(l_{1,n})$ is either constant or monotonically tending to infinity. These properties are preserved under moving to further subsequences, thus we repeat this for the sequences $(l_{2,n}), (l_{3,n}), \dots, (l_{m,n})$. Now we are in the situation where each e_j corresponds to a constant sequence or a monotonic sequence tending to infinity. The constant sequences can be replaced by fixed paths, which we incorporate into M (now allowing degree/valency-2 vertices), and we henceforth assume that every sequence $(l_{j,n})$ monotonically tends to infinity.

Suppose our sequence (S_r) has s increasingly subdivided internal edges and t increasingly subdivided pendant edges. Form another sequence of radical integer forests by

removing a vertex near the middle of each increasingly subdivided internal path of each S_r , giving $2s + t$ increasingly subdivided pendant edges. We obtain a new sequence (T_r) of radical integer forests with n_1, \dots, n_{2s+t} for the lengths of its pendant paths.

Claim 1. *For n_1, \dots, n_{2s+t} all sufficiently large, we have a Salem forest.*

Suppose that the forests of (T_r) are cyclotomic for all n_1, \dots, n_{2s+t} . Then each connected component of these forests must be a subtree of \tilde{B}_n . Therefore, connecting the broken internal paths back together (to get back to some S_k) would give a cyclotomic radical integer tree, but this is a contradiction since all of the elements of (S_r) are Salem trees. Each T_k can have at most one eigenvalue greater than 2, since otherwise, by Theorem 1.6, the corresponding S_k would also have at least two eigenvalues greater than 2.

By Lemma 2.25, the sequences $(\tau(T_r))$ and $(\tau(S_r))$ have the same limit and by applying Corollary 2.24 to (T_r) we have that this limit is a Pisot number. The second sentence of the theorem is automatic. ■

Hermitian Matrices over Imaginary Quadratic Integer Rings

Recall that a cyclotomic matrix is a Hermitian matrix A whose associated reciprocal polynomial R_A has integer coefficients and Mahler measure $M(R_A) = 1$. Cyclotomic matrices over the rational integers and over the imaginary quadratic integer rings $\mathcal{O}_{\mathbb{Q}(\sqrt{d})}$ for $d \neq -1$ and $d \neq -3$ have been classified by McKee and Smyth [25] and Taylor [40] respectively. Also, Lehmer's problem has been confirmed for polynomials R_A where A is a Hermitian matrix over \mathbb{Z} and over $\mathcal{O}_{\mathbb{Q}(\sqrt{d})}$ for $d = -2$ and $d < -3$ by McKee and Smyth [26] and Taylor [41, 39]. Let \mathcal{O}_K denote the ring of integers of a number field K . In this chapter, for $d = -1$ and $d = -3$, we classify cyclotomic $\mathcal{O}_{\mathbb{Q}(\sqrt{d})}$ -matrices and we reduce Lehmer's problem to a finite search for the polynomials R_A , where A is a Hermitian $\mathcal{O}_{\mathbb{Q}(\sqrt{d})}$ -matrix. Our methods can be used to classify cyclotomic matrices over $\mathcal{O}_{\mathbb{Q}(\sqrt{d})}$ for all $d \in \mathbb{Z}$.

For Hermitian matrices A over an imaginary quadratic ring $\mathcal{O}_{\mathbb{Q}(\sqrt{d})}$ the integrality of the characteristic polynomial is automatic. The nontrivial Galois automorphism σ of $\mathbb{Q}(\sqrt{d})$ (with $d \in \mathbb{Z}_-$) over \mathbb{Q} is simply complex conjugation. Applying σ to the coefficients of χ_A gives

$$\sigma(\chi_A(x)) = \det(xI - \sigma(A)) = \det(xI - A^T) = \chi_A(x).$$

Hence, the coefficients of χ_A are rational, and since they are also algebraic integers, they must be in \mathbb{Z} .

3.1 Cyclotomic matrices over $\mathbb{Z}[i]$ and $\mathbb{Z}[\omega]$

3.1.1 Graph drawing conventions

Here we outline our graph drawing conventions. We are interested in S -graphs where $S = \mathbb{Z}[i]$ and $S = \mathbb{Z}[\omega]$ (where $\omega = 1/2 + \sqrt{-3}/2$). Edges are drawn in accordance with Tables 3.1 and 3.2. It will become clear later why the edges in these tables are sufficient for

Edge-weight	Visual representation
1	———
-1	-----
i	——→
$-i$	---→---
$1+i$	——→→
$-1-i$	---→→---
2	— 2 —

Table 3.1: Edge drawing convention for $\mathbb{Z}[i]$ -graphs.

our purposes. For edges with a real edge-weight, the direction of the edge does not matter, and so to reduce clutter we do not draw arrows for these edges. For all other edges, the number of arrowheads reflects the norm of the edge-weight.

Edge-weight	Visual representation
1	———
-1	-----
ω	——→
$-\omega$	---→---
$1+\omega$	——→→→
$-1-\omega$	---→→→---
2	— 2 —

Table 3.2: Edge drawing convention for $\mathbb{Z}[\omega]$ -graphs.

A vertex with charge 1 is drawn as \oplus and a vertex with charge -1 is drawn as \ominus . For charge 2 we draw \odot . If a vertex is uncharged, we simply draw \bullet . A hollow vertex is drawn as

$$\oplus, \ominus, \text{ or } \circ,$$

with respect to its charge.

3.1.2 Classification of cyclotomic matrices over $\mathbb{Z}[i]$

We split up the classification of cyclotomic matrices over $\mathbb{Z}[i]$ into three parts and prove each part separately.

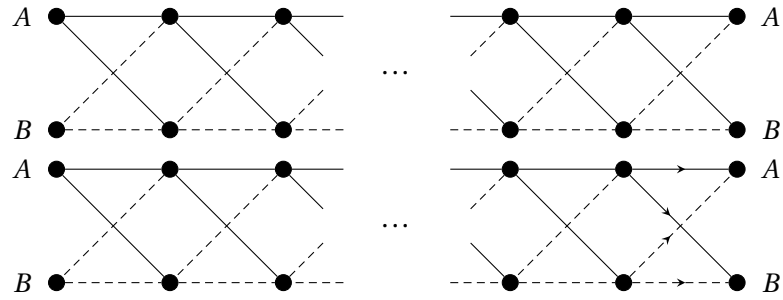

Figure 3.1: The families T_{2k} and $T_{2k}^{(x)}$ (respectively) of $2k$ -vertex maximal connected cyclotomic $\mathbb{Z}[x]$ -graphs, for $k \geq 3$ and $x \in \{i, \omega\}$. (The two copies of vertices A and B should be identified to give a toral tessellation.)

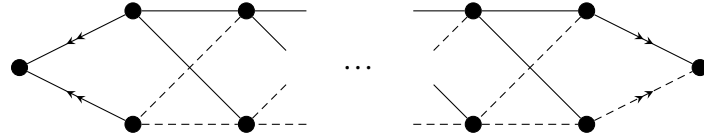

Figure 3.2: The family of $2k$ -vertex maximal connected cyclotomic $\mathbb{Z}[i]$ -graphs C_{2k} for $k \geq 2$.

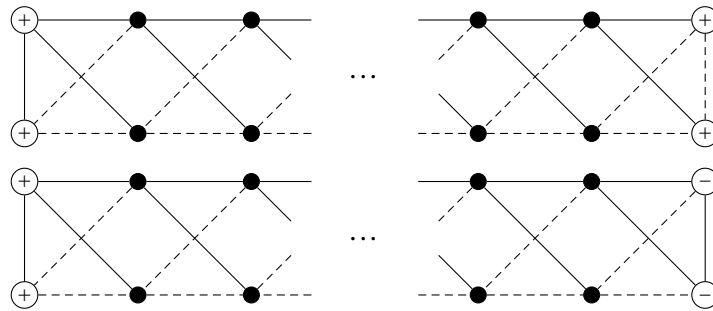

Figure 3.3: The families of $2k$ -vertex maximal connected cyclotomic \mathbb{Z} -graphs C_{2k}^{++} and C_{2k}^{+-} for $k \geq 2$.

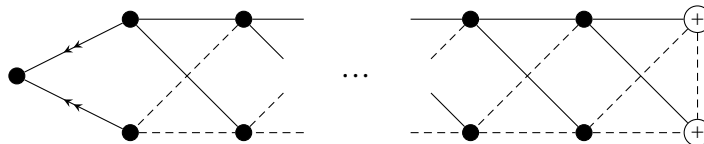

Figure 3.4: The family of $(2k + 1)$ -vertex maximal connected cyclotomic $\mathbb{Z}[i]$ -graphs C_{2k+1} for $k \geq 1$.

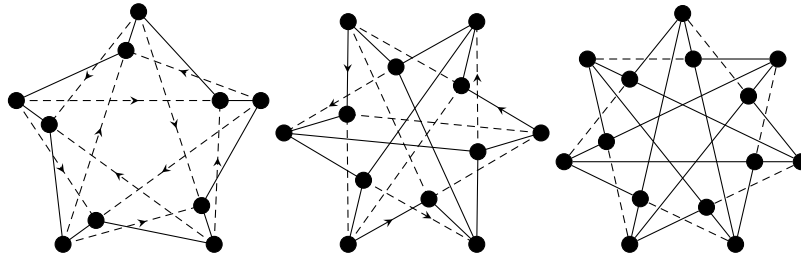

Figure 3.5: The sporadic maximal connected cyclotomic $\mathbb{Z}[\omega]$ -graphs S_{10} , S_{12} , and S_{14} of orders 10, 12, and 14 respectively. The \mathbb{Z} -graph S_{14} is also a $\mathbb{Z}[i]$ -graph.

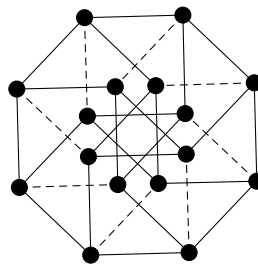

Figure 3.6: The sporadic maximal connected cyclotomic \mathbb{Z} -hypercube S_{16} .

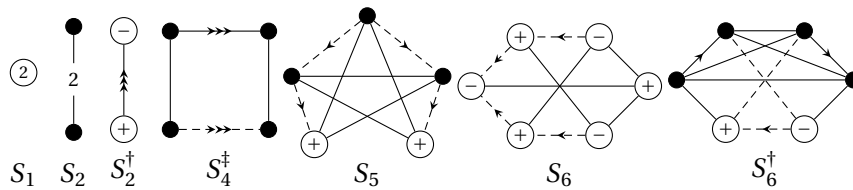

Figure 3.7: The sporadic maximal connected cyclotomic $\mathbb{Z}[\omega]$ -graphs of orders 1, 2, 4, 5, and 6. The \mathbb{Z} -graphs S_1 and S_2 are also $\mathbb{Z}[i]$ -graphs.

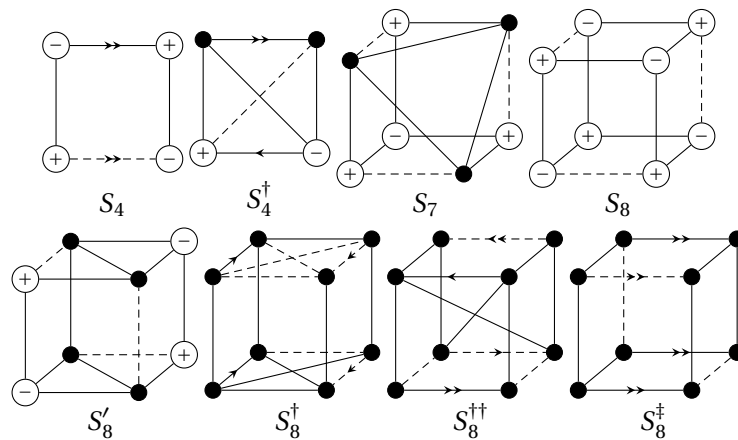

Figure 3.8: The sporadic maximal connected cyclotomic $\mathbb{Z}[i]$ -graphs of orders 4, 7, and 8. The \mathbb{Z} -graphs S_7 , S_8 , and S'_8 are also $\mathbb{Z}[\omega]$ -graphs.

Theorem 3.1 (Uncharged with unit entries). *Let A be a maximal indecomposable cyclotomic matrix that has only zeros on the diagonal and whose nonzero entries are units from the ring $\mathbb{Z}[i]$. Then A is equivalent to an adjacency matrix of one of the graphs T_{2k} , $T_{2k}^{(i)}$, S_8^\dagger , S_{14} , and S_{16} in Figures 3.1, 3.5, 3.6, and 3.8.*

Theorem 3.2 (Uncharged). *Let A be a maximal indecomposable cyclotomic $\mathbb{Z}[i]$ -matrix that has only zeros on the diagonal, and at least one entry of A has norm greater than 1. Then A is equivalent to an adjacency matrix of one of the graphs C_{2k} , S_2 , $S_8^{\dagger\dagger}$, and S_8^\ddagger in Figures 3.2 and 3.8.*

Theorem 3.3 (Charged). *Let A be a maximal indecomposable cyclotomic $\mathbb{Z}[i]$ -matrix that has at least one nonzero entry on the diagonal. Then A is equivalent to an adjacency matrix of one of the graphs C_{2k}^{++} , C_{2k}^{+-} , C_{2k+1} , S_1 , S_4 , S_4^\dagger , S_7 , S_8 , and S_8' in Figures 3.3, 3.4, and 3.8.*

The theorems above give a complete classification of cyclotomic matrices over the Gaussian integers as follows.

Theorem 3.4 (Cyclotomic matrices over the Gaussian integers). *Let A be a maximal indecomposable cyclotomic matrix over the ring $\mathbb{Z}[i]$. Then A is equivalent to an adjacency matrix of one of the graphs from Theorems 3.1, 3.2, or 3.3.*

Moreover, every indecomposable cyclotomic $\mathbb{Z}[i]$ -matrix is contained in a maximal one.

3.1.3 Classification of cyclotomic matrices over $\mathbb{Z}[\omega]$

As with the classification over the Gaussian integers, we split up the result to deal with uncharged graphs and charged graphs separately.

Theorem 3.5 (Uncharged). *Let A be a maximal indecomposable cyclotomic $\mathbb{Z}[\omega]$ -matrix that has only zeros on the diagonal. Then A is equivalent to an adjacency matrix of one of the graphs T_{2k} , $T_{2k}^{(\omega)}$, S_2 , S_4^\dagger , S_{10} , S_{12} , S_{14} , and S_{16} in Figures 3.1, 3.5, 3.6, 3.7, and 3.8.*

Theorem 3.6 (Charged). *Let A be a maximal indecomposable cyclotomic $\mathbb{Z}[\omega]$ -matrix that has at least one nonzero entry on the diagonal. Then A is equivalent to an adjacency matrix of one of the graphs S_1 , S_2^\dagger , C_{2k}^{++} , C_{2k}^{+-} , S_4^\dagger , S_5 , S_6 , S_6^\dagger , S_7 , S_8 , and S_8' in Figures 3.3, 3.7, and 3.8.*

Again, the theorems above give a complete classification of cyclotomic matrices over the Eisenstein integers.

Theorem 3.7 (Cyclotomic matrices over the Eisenstein integers). *Let A be a maximal indecomposable cyclotomic matrix over the ring $\mathbb{Z}[\omega]$. Then A is equivalent to an adjacency matrix of one of the graphs from Theorems 3.5 or 3.6.*

Moreover, every indecomposable cyclotomic $\mathbb{Z}[\omega]$ -matrix is contained in a maximal one.

Nowhere in our proofs of the above theorems do we use McKee and Smyth's classification of cyclotomic integer symmetric matrices. We do, however, expand on their technique of using Gram matrices and excluded subgraphs. Part of the proof of their classification used the classification of indecomposable line systems. Despite our not making use of line systems, there does appear to be a relation between the uncharged case of this classification and unitary line systems, see [21].

Following McKee and Smyth [25], we remark that all the maximal connected cyclotomic graphs (with adjacency matrices A) of Theorems 3.4 and 3.7 are 'visibly' cyclotomic: $A^2 = 4I$, hence all their eigenvalues are ± 2 . It is easy to see that 'visibly' cyclotomic graphs are maximal. Each vertex of such a graph has degree equal to 4 and hence any connected supergraph would have to have a vertex of degree greater than 4. By Corollary 1.8, such a supergraph cannot be cyclotomic. Therefore, the classifications reduce to showing that every cyclotomic graph is contained in one of the maximal cyclotomic graphs given in the figures above.

In Sections 3.3, 3.4, and 3.5 we will use heavily material from Section 3.2

3.2 Excluded subgraphs and Gram matrices

In this section we set up some machinery which we will use to classify cyclotomic matrices over quadratic integer rings. We will also refer to this section in Chapter 4.

3.2.1 Excluding subgraphs

If a graph is not cyclotomic, then by Theorem 1.6, it cannot be a subgraph of a cyclotomic graph. We call such a graph an **excluded subgraph of type I**.

Certain connected cyclotomic graphs have the property that if one tries to grow them to give larger connected cyclotomic graphs then one always stays inside one of a finite number of fixed maximal connected cyclotomic graphs. We call a graph with this property an **excluded subgraph of type II**. Given a connected cyclotomic graph G and a finite list

L of maximal connected cyclotomic graphs containing G , we describe the process used to determine whether or not a graph G has this property. Consider all possible ways of attaching a vertex to G such that the resulting graph H is both connected and cyclotomic. Check that each supergraph H is equivalent to a subgraph of one of the graphs in L (if not then G is *not* an excluded subgraph of type II with respect to the list L). Repeat this process with all supergraphs H . Since L is a finite list of graphs on a finite number of vertices, this process terminates.

Given a list \mathcal{L} of graphs, we define a \mathcal{L} -**free** graph to be a connected cyclotomic graph that does not contain any graph equivalent to any graph in \mathcal{L} . We have included being both *connected* and *cyclotomic* in this definition to ease the terminology below. We shall have cause to use different lists at various points in our proofs.

3.2.2 Cyclotomic matrices and Gram matrices

Let S be a subset of \mathbb{C} and suppose G is a cyclotomic S -graph with adjacency matrix A . Then all of the eigenvalues of A are contained in the interval $[-2, 2]$. The matrix $M = A + 2I$ is positive semidefinite and therefore decomposes as $M = B^*B$, where the columns of B are vectors in a unitary space \mathbb{C}^m for some arbitrary $m \in \mathbb{N}$. Hence M is the Gram matrix for the set of vectors forming the columns of B ; these vectors are called **Gram vectors**. Each vertex v of G has a corresponding Gram vector \mathbf{v} and the inner product of Gram vectors \mathbf{u} and \mathbf{v} correspond to the adjacency of the vertices u and v . By examining the diagonal of the Gram matrix, one can see that Gram vectors corresponding to uncharged vertices have squared length 2. Similarly, a Gram vector corresponding to a vertex of charge $+1$ (respectively -1) has squared length 3 (respectively 1).

Gram vector constraints

In the proof of the classification of cyclotomic matrices in this chapter and the next, we exploit the dependencies of Gram vectors that satisfy certain conditions as outlined in the next lemma.

Lemma 3.8. *Let G be a cyclotomic graph. Suppose that G has uncharged vertices x_1, x_2, x_3 , and x_4 whose Gram vectors $\mathbf{x}_1, \mathbf{x}_2, \mathbf{x}_3$, and \mathbf{x}_4 are pairwise orthogonal and suppose that the Gram vector \mathbf{v} for an uncharged vertex $v \in V(G)$ satisfies*

$$|\langle \mathbf{v}, \mathbf{x}_1 \rangle| = \cdots = |\langle \mathbf{v}, \mathbf{x}_4 \rangle| = 1.$$

Then we can write

$$2\mathbf{v} = \langle \mathbf{v}, \mathbf{x}_1 \rangle \mathbf{x}_1 + \langle \mathbf{v}, \mathbf{x}_2 \rangle \mathbf{x}_2 + \langle \mathbf{v}, \mathbf{x}_3 \rangle \mathbf{x}_3 + \langle \mathbf{v}, \mathbf{x}_4 \rangle \mathbf{x}_4.$$

Proof. With λ_j s in \mathbb{C} , we write

$$\mathbf{v} = \lambda_1 \mathbf{x}_1 + \lambda_2 \mathbf{x}_2 + \lambda_3 \mathbf{x}_3 + \lambda_4 \mathbf{x}_4 + \xi, \quad (3.1)$$

with ξ orthogonal to each \mathbf{x}_j . Taking inner products with equation (3.1) and each \mathbf{x}_j gives

$$\lambda_j = \frac{\langle \mathbf{v}, \mathbf{x}_j \rangle}{2}.$$

Now we write

$$2\mathbf{v} = \langle \mathbf{v}, \mathbf{x}_1 \rangle \mathbf{x}_1 + \langle \mathbf{v}, \mathbf{x}_2 \rangle \mathbf{x}_2 + \langle \mathbf{v}, \mathbf{x}_3 \rangle \mathbf{x}_3 + \langle \mathbf{v}, \mathbf{x}_4 \rangle \mathbf{x}_4 + 2\xi. \quad (3.2)$$

By taking the inner product of equation (3.2) with \mathbf{v} , we see that $\langle \xi, \mathbf{v} \rangle = 0$ and hence, using (3.1), we have $\xi = 0$. ■

Hollow vertices and saturated vertices

Let H be a cyclotomic S -graph contained in some cyclotomic S -graph H' . Given H' and H , we refer to the vertices $V(H') \setminus V(H)$ as the **hollow vertices** of H . For a graph G , let $N_G(v)$ denote the set of neighbours of v in G , those vertices $u \in V(G)$ with nonzero weight $w(u, v)$. We define the **hollow-degree** of a vertex $v \in V(H)$ as

$$d_{H'}(v) = \sum_{u \in N_{H'}(v)} |w(u, v)|^2.$$

This generalises the degree of a vertex $v \in V(H)$, which is given by $d_H(v)$. Let $V'_4(H)$ denote the subset of vertices of H that have hollow-degree 4, i.e., the set

$$\{v \in V(H) : d_{H'}(v) = 4\}.$$

Since H and H' are cyclotomic each of their vertices v has a corresponding Gram vector \mathbf{v} . Our notion of switching carries through to vectors naturally; we say that two vectors \mathbf{u} and \mathbf{v} are **switch-equivalent** if $\mathbf{u} = x\mathbf{v}$ for some x with $|x| = 1$. Accordingly, the vertices u and v are called **switch-equivalent** if their corresponding Gram vectors are switch-equivalent. Let G be a cyclotomic graph that contains H and let $N'_G(v)$ denote the set of vertices $u \in N_G(v)$ such that u is switch-equivalent to some vertex in $V(H')$. Define $\mathcal{V}_G(H)$ to be the subset of $V(G)$ consisting of the vertices of H and their adjacent vertices that are switch-equivalent to hollow vertices, in symbols

$$\mathcal{V}_G(H) = \bigcup_{v \in V(H)} N'_G(v).$$

Let $S \subset \mathbb{C}$, let \mathcal{L} be a list of graphs, and let H and H' be graphs such that H' contains H . A vertex $v \in V(H)$ is called H' -**saturated in H** if, for any \mathcal{L} -free S -graph G containing H , each vertex in $N_G(v)$ is switch-equivalent to some hollow vertex, i.e., $N_G(v) = N'_G(v)$. Note that the definition of a vertex being H' -saturated in H depends on the set S , the list \mathcal{L} , and the graphs H and H' . Any vertex that is H' -saturated in H is also G' -saturated in G where G and G' are supergraphs of H and H' respectively. We refer imprecisely to these vertices simply as ‘saturated vertices’.

3.3 Proof of Theorem 3.1

In this section we prove Theorem 3.1 and hence we restrict our attention to the set $S = \{0, \pm 1, \pm i\}$.

3.3.1 Excluded subgraphs

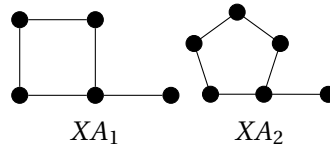

Figure 3.9: some non-cyclotomic uncharged \mathbb{Z} -graphs.

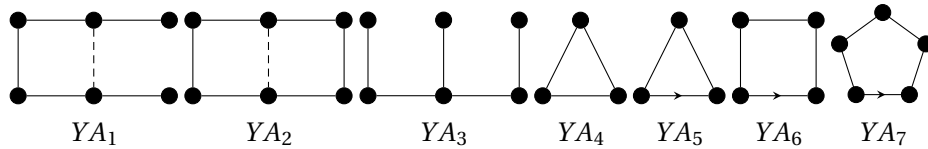

Figure 3.10: some cyclotomic $\mathbb{Z}[i]$ -graphs that are contained as subgraphs of fixed maximal connected cyclotomic $\mathbb{Z}[i]$ -graphs.

In Table 3.3 we list each excluded subgraph of type II in Figure 3.10 along with every maximal connected cyclotomic $\mathbb{Z}[i]$ -graph that contains it. Let \mathcal{L}_1 consist of vertices of charge ± 1 and the graphs from Figure 3.10. Hence, all \mathcal{L}_1 -free S -graphs are uncharged and, since YA_4 and YA_5 are excluded, no \mathcal{L}_1 -free S -graph can contain a subgraph whose underlying graph is a triangle. We refer to this fact as the ‘exclusion of triangles’. For this section, the notion of a saturated vertex will depend on the list \mathcal{L}_1 .

Excluded subgraph	Maximal cyclotomics
YA_1	S_{14} and S_{16}
YA_2	S_{14} and S_{16}
YA_3	S_{14} and S_{16}
YA_4	T_6 and S_7
YA_5	$T_6^{(i)}$ and S_8^\dagger
YA_6	$T_8^{(i)}$ and $S^\dagger \dagger_8$
YA_7	$T_{10}^{(i)}$

Table 3.3: Excluded subgraphs from Figure 3.10 and (up to equivalence) their containing maximal connected cyclotomic $\mathbb{Z}[i]$ -graphs.

3.3.2 Inductive Lemmata

Define $P_{l,r}$ (solid vertices) and $P'_{l,r}$ (solid and hollow vertices) with the following \mathbb{Z} -graph

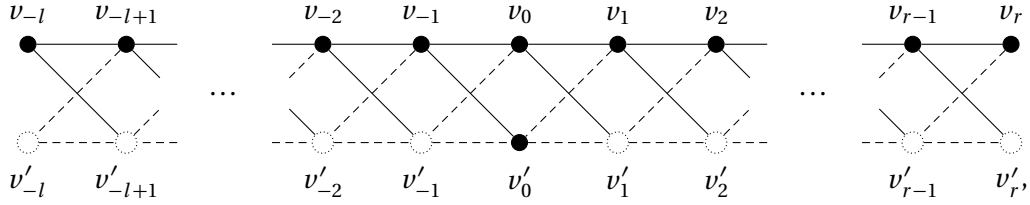

where $l \geq 0$ and $r \geq 0$. Here, the set of hollow vertices of $P_{l,r}$ is the set $V(P'_{l,r}) \setminus V(P_{l,r})$. Clearly both $P_{l,r}$ and $P'_{l,r}$ are cyclotomic since they are contained in $T_{2(l+r+2)}$. Note that $P_{l,r}$ has $l+r+2$ vertices and $P'_{l,r}$ has $2(l+r+1)$ vertices. The set $V'_4(P_{l,r})$ of vertices of $P_{l,r}$ having hollow-degree 4 is the set $\{v_j : -l < j < r\} \cup \{v'_0\}$.

Lemma 3.9. *In $P_{l,r}$ for $l \geq 2$ or $r \geq 2$, we can write the Gram vector for each hollow vertex in terms of Gram vectors of the vertices as follows:*

$$\mathbf{v}'_{-t} = \mathbf{v}_{-t} + 2 \sum_{j=1}^{t-1} (-1)^{t+j} \mathbf{v}_{-j} + (-1)^t (\mathbf{v}_0 + \mathbf{v}'_0), \quad \text{for } t \in \{1, \dots, l\}.$$

$$\mathbf{v}'_t = -\mathbf{v}_t - 2 \sum_{j=1}^{t-1} (-1)^{t+j} \mathbf{v}_j - (-1)^t (\mathbf{v}_0 - \mathbf{v}'_0), \quad \text{for } t \in \{1, \dots, r\}.$$

Proof. We will prove the lemma for \mathbf{v}'_t where $t \in \{1, \dots, r\}$, the details are similar for \mathbf{v}'_{-t} where $t \in \{1, \dots, l\}$. By Lemma 3.8 we can write

$$2\mathbf{v}_1 = \mathbf{v}_2 + \mathbf{v}'_2 + \mathbf{v}_0 - \mathbf{v}'_0 \quad (3.3)$$

$$2\mathbf{v}'_1 = -\mathbf{v}_2 - \mathbf{v}'_2 + \mathbf{v}_0 - \mathbf{v}'_0. \quad (3.4)$$

From equation (3.3), we see that \mathbf{v}'_2 has the required form. Combining equations (3.3) and (3.4) gives

$$\mathbf{v}'_1 = -\mathbf{v}_1 + \mathbf{v}_0 - \mathbf{v}'_0.$$

By Lemma 3.8, for $k \in \{1 - l, \dots, r - 1\}$, we can write

$$2\mathbf{v}_k = \mathbf{v}_{k+1} + \mathbf{v}'_{k+1} + \mathbf{v}_{k-1} - \mathbf{v}'_{k-1}. \quad (3.5)$$

Suppose the lemma holds for all $1 \leq t \leq k$ so that, in particular,

$$\mathbf{v}'_{k-1} = -\mathbf{v}_{k-1} - 2 \sum_{j=1}^{k-2} (-1)^{k-1+j} \mathbf{v}_j - (-1)^{k-1} (\mathbf{v}_0 - \mathbf{v}'_0). \quad (3.6)$$

Rearranging equation (3.5) and substituting equation (3.6) gives

$$\mathbf{v}'_{k+1} = -\mathbf{v}_{k+1} - 2 \sum_{j=1}^k (-1)^{k+1+j} \mathbf{v}_j - (-1)^{k+1} (\mathbf{v}_0 - \mathbf{v}'_0),$$

and hence the lemma follows by induction. ■

Lemma 3.10 (Saturated vertices). *Let G be an \mathcal{L}_1 -free S -graph containing $P_{l,r}$ with $l+r > 2$. Then, for each vertex $v \in V'_4(P_{l,r})$, we have $N_G(v) = N'_G(v)$. Hence, each vertex in $V'_4(P_{l,r})$ is $P'_{l,r}$ -saturated in $P_{l,r}$.*

Proof. Fix Gram vectors for $P'_{l,r}$. We want to show that, for all vertices $v \in V'_4(P_{l,r})$, we have $N_G(v) = N'_G(v)$. Since $P'_{l,r}$ contains $P_{l,r}$, we have $N_G(v) \cap V(P_{l,r}) = N'_G(v) \cap V(P_{l,r})$ for all vertices $v \in V(G)$. Hence, we consider a vertex $v \in V(G) \setminus V(P_{l,r})$ adjacent to some vertex $w \in V'_4(P_{l,r})$ and show that v is switch-equivalent to some hollow vertex, i.e., a vertex in $V(P'_{l,r}) \setminus V(P_{l,r})$. Split into two cases.

Case 1. v_0 has hollow-degree 4. Hence, both r and l are nonzero. We can assume that $r \geq 2$ (and $l \geq 1$). We consider vertices $v'_0, v_j \in V'_4(P_{l,r})$ where $j \geq 0$. The arguments are similar for $j \leq 0$. Suppose that v is adjacent to v_j for some $j \geq 0$. Working up to a switching of v , we can assume that $\langle \mathbf{v}, \mathbf{v}_j \rangle = 1$.

First suppose $j = 0$. Lemma 3.9, gives us the following equalities:

$$\mathbf{v}'_{-1} = \mathbf{v}_{-1} - \mathbf{v}_0 - \mathbf{v}'_0; \quad (3.7)$$

$$\mathbf{v}'_1 = -\mathbf{v}_1 + \mathbf{v}_0 - \mathbf{v}'_0. \quad (3.8)$$

Since we have excluded triangles, \mathbf{v} is orthogonal to both \mathbf{v}_{-1} and \mathbf{v}_1 . We have assumed that $r \geq 2$ and $l \geq 1$, and since we have excluded YA_1 , the vertex v must be adjacent to

at least one of the vertices v'_0 and v_2 . But the exclusion of subgraphs XA_1 , YA_2 , and YA_6 imply that v must be adjacent to v'_0 . Moreover, $\langle \mathbf{v}, \mathbf{v}'_0 \rangle = \pm 1$ for otherwise G would contain YA_6 . In either case, using equations (3.7) and (3.8), we obtain that \mathbf{v} is switch-equivalent to either \mathbf{v}'_1 or \mathbf{v}'_{-1} . Thus v_0 is $P'_{l,r}$ -saturated in $P_{l,r}$. Similarly, v'_0 is also $P'_{l,r}$ -saturated in $P_{l,r}$.

Second, suppose $j = 1$. Exclusion of triangles implies that \mathbf{v} is orthogonal to all of \mathbf{v}_0 , \mathbf{v}'_0 , and \mathbf{v}_2 . By Lemma 3.8, we have

$$2\mathbf{v}_1 = \mathbf{v}_0 - \mathbf{v}'_0 + \mathbf{v}_2 + \mathbf{v}'_2. \quad (3.9)$$

Now, by taking the inner product of \mathbf{v} and equation (3.9) we find that $\mathbf{v} = \mathbf{v}'_2$. Hence v_1 is $P'_{l,r}$ -saturated in $P_{l,r}$.

If $r = 2$ we are done, so we assume that $r > 2$. For our final basic case we suppose that $j = 2$. Exclusion of triangles implies that \mathbf{v} is orthogonal to both \mathbf{v}_1 and \mathbf{v}_3 . If v is adjacent to either v_0 or v'_0 , then since they are $P'_{l,r}$ -saturated in $P_{l,r}$, \mathbf{v} must be switch-equivalent to either \mathbf{v}'_1 or \mathbf{v}'_{-1} , and since \mathbf{v}_2 is orthogonal to \mathbf{v}'_{-1} , \mathbf{v} must be switch-equivalent to \mathbf{v}'_1 . Otherwise, if v is adjacent to neither v_0 nor v'_0 then, from equation (3.8), we have $\langle \mathbf{v}'_1, \mathbf{v} \rangle = 0$. By Lemma 3.8, we have the equality

$$2\mathbf{v}_2 = \mathbf{v}_1 - \mathbf{v}'_1 + \mathbf{v}_3 + \mathbf{v}'_3. \quad (3.10)$$

From taking the inner product of \mathbf{v} with equation (3.10) it follows that $\mathbf{v} = \mathbf{v}'_3$.

Thus the vertices v_0 , v_1 , and v_2 are $P'_{l,r}$ -saturated in $P_{l,r}$. If $r = 3$ then we are done. Otherwise we assume that $2 < t < r$ and that each vertex v_j with $0 \leq j < t$ is $P'_{l,r}$ -saturated in $P_{l,r}$. It suffices now to show that v_t is $P'_{l,r}$ -saturated in $P_{l,r}$. Suppose that $v \in V(G) \setminus V(P_{l,r})$ is adjacent to v_t . We split into cases.

Case 1.1. v is adjacent to v_{t-2} . By our inductive hypothesis, v_{t-2} is $P'_{l,r}$ -saturated in $P_{l,r}$ and thus \mathbf{v} is switch-equivalent to the Gram vector of some hollow vertex. Moreover, the hollow vertex in question must be adjacent to both v_t and v_{t-2} . Hence \mathbf{v} is switch-equivalent to \mathbf{v}'_{t-1} .

Case 1.2. v is not adjacent to v_{t-2} . Hence \mathbf{v} is orthogonal to \mathbf{v}_{t-2} . The exclusion of triangles implies that \mathbf{v} is also orthogonal to both \mathbf{v}_{t-1} and \mathbf{v}_{t+1} . Now, our inductive hypothesis says that if v is adjacent to a vertex $v_j \in V_4'(P_{l,r})$ then \mathbf{v} is switch-equivalent to some hollow vertex. But for $0 \leq k \leq t-3$ there are no hollow vertices adjacent to

both v_k and v_t . Therefore \mathbf{v} must be orthogonal to all of $\mathbf{v}_0, \mathbf{v}'_0, \mathbf{v}_1, \dots, \mathbf{v}_{t-3}$. By Lemma 3.9, the vector \mathbf{v}'_{t-1} is a linear combination of the Gram vectors $\mathbf{v}_0, \mathbf{v}'_0, \mathbf{v}_1, \dots, \mathbf{v}_{t-1}$, and hence $\langle \mathbf{v}'_{t-1}, \mathbf{v} \rangle = 0$. By Lemma 3.8 we can write

$$2\mathbf{v}_t = \mathbf{v}_{t-1} - \mathbf{v}'_{t-1} + \mathbf{v}_{t+1} + \mathbf{v}'_{t+1}. \quad (3.11)$$

The inner product of \mathbf{v} and equation (3.11) gives $\langle \mathbf{v}, \mathbf{v}'_{t+1} \rangle = 2$. Hence $\mathbf{v} = \mathbf{v}'_{t+1}$ as required.

Case 2. v_0 does not have hollow-degree 4. Up to equivalence, we can assume that $l = 0$ and $r \geq 3$. We consider vertices $v_j \in V'_4(P_{l,r})$ where $j \geq 1$. Suppose that v is adjacent to v_j . We can assume that $\langle \mathbf{v}, \mathbf{v}_j \rangle = 1$. The lemma holds for $j = 1$ just as in Case 1.

Suppose $j = 2$. Since triangles are excluded, v is adjacent to neither v_1 nor v_3 . If v is adjacent to either v_0 or v'_0 then the exclusion of XA_1, YA_1 , and YA_6 forces $\langle \mathbf{v}, \mathbf{v}_0 \rangle = -1$ and $\langle \mathbf{v}, \mathbf{v}'_0 \rangle = 1$. And taking the inner product of \mathbf{v} with equation (3.8) gives $\mathbf{v} = -\mathbf{v}'_1$. Otherwise, if v is adjacent to neither v_0 nor v'_0 then by equation (3.8), \mathbf{v} is orthogonal to \mathbf{v}'_1 . Hence, taking the inner product of \mathbf{v} with the equation

$$2\mathbf{v}_2 = \mathbf{v}_1 - \mathbf{v}'_1 + \mathbf{v}_3 + \mathbf{v}'_3$$

gives $\mathbf{v} = \mathbf{v}'_3$. Therefore, the vertex v_2 is $P'_{l,r}$ -saturated in $P_{l,r}$.

If $r = 3$ then we are done. Otherwise suppose $r \geq 4$ and assume that $2 < t < r$ and that the lemma holds when v is adjacent to v_j with $0 \leq j < t$. Letting $j = t$, again we split into cases.

Case 2.1. v is adjacent to v_{t-2} . This is the same as in Case 1.1.

Case 2.2. v is not adjacent to v_{t-2} . The possibility of v being adjacent to v_0 or v'_0 is ruled out by the excluded subgraphs XA_2 and YA_7 if $t = 3$ and by YA_3 if $t > 3$. Hence \mathbf{v} is orthogonal to both \mathbf{v}_0 and \mathbf{v}'_0 . Now the argument is the same as in Case 1.2. ■

Let G be an \mathcal{L}_1 -free S -graph containing $P_{l,r}$ with $l + r > 2$. By the symmetry of the graph $P'_{l,r}$, it follows from Lemma 3.10 that each vertex in $V'_4(\mathcal{V}_G(P_{l,r}))$ is $P'_{l,r}$ -saturated in $\mathcal{V}_G(P_{l,r})$.

Lemma 3.11 (Left adjacency). *Let G be an \mathcal{L}_1 -free S -graph containing $P_{l,r}$ with $l + r > 2$, where a vertex $v \in V(G) \setminus \mathcal{V}_G(P_{l,r})$ is adjacent to v_{-1} but not to v_r . Then \mathbf{v} is orthogonal to all of the vectors \mathbf{v}_j and \mathbf{v}'_j , for $j \in \{1 - l, \dots, r\}$. Hence G contains a subgraph equivalent to $P_{l+1,r}$.*

Notice that here we are using the set $\mathcal{V}_G(P_{l,r})$ of vertices of $P_{l,r}$ and their adjacent vertices that are switch-equivalent to hollow vertices, as defined in Section 3.2.

Proof. By Lemma 3.10, the vertices v_{1-l}, \dots, v_{r-1} are $P'_{l,r}$ -saturated in $P_{l,r}$, and so all of their neighbours are in $\mathcal{V}_G(P_{l,r})$, hence \mathbf{v} is orthogonal to their Gram vectors. And by assumption, we have $\langle \mathbf{v}, \mathbf{v}_r \rangle = 0$.

First suppose that $l > 0$. By Lemma 3.9, for each $j \in \{1-l, \dots, r\}$, we can write \mathbf{v}'_j as a linear combination of the Gram vectors $\mathbf{v}_{1-l}, \dots, \mathbf{v}_r$. Therefore \mathbf{v} is orthogonal to each \mathbf{v}'_j as required. We can assume that $\langle \mathbf{v}, \mathbf{v}_{-l} \rangle = 1$ and hence G contains a subgraph equivalent to $P_{l+1,r}$.

Finally suppose that $l = 0$, then by assumption, $r \geq 3$. We can assume that $\langle \mathbf{v}, \mathbf{v}_0 \rangle = 1$. Now, v'_0 is a vertex of G so $\langle \mathbf{v}, \mathbf{v}'_0 \rangle$ is in S . The exclusion of YA_3 causes $\langle \mathbf{v}, \mathbf{v}'_0 \rangle \neq 0$. And the excluded subgraphs XA_1 and YA_6 force the inner product $\langle \mathbf{v}, \mathbf{v}'_0 \rangle = 1$. Therefore, we have $\langle \mathbf{v}, \mathbf{v}_j \rangle = 0$ for all $j \in \{1, \dots, r\}$ and $\langle \mathbf{v}, \mathbf{v}_0 - \mathbf{v}'_0 \rangle = 0$. Apply Lemma 3.9. Thence we are done. ■

Lemma 3.12 (Right adjacency). *Let G be an \mathcal{L}_1 -free S -graph containing $P_{l,r}$ with $l+r > 2$, where a vertex $v \in V(G) \setminus \mathcal{V}_G(P_{l,r})$ is adjacent to v_r but not to v_{-l} . Then \mathbf{v} is orthogonal to all of the vectors \mathbf{v}_j and \mathbf{v}'_j , for $j \in \{-l, \dots, r-1\}$. Hence G contains a subgraph equivalent to $P_{l,r+1}$.*

Proof. Similar to the proof of Lemma 3.11. ■

Lemma 3.13 (Left/Right orthogonality). *Let G be an \mathcal{L}_1 -free S -graph containing $P_{l,r}$ with $l+r > 2$, where a vertex $v \in V(G) \setminus \mathcal{V}_G(P_{l,r})$ is adjacent to v_{-l} and v_r . Then \mathbf{v} is orthogonal to all of the vectors \mathbf{v}_j and \mathbf{v}'_j , for $j \in \{1-l, \dots, r-1\}$.*

Proof. By Lemma 3.10, the vertices v_j are $P'_{l,r}$ -saturated in $P_{l,r}$ for all $j \in \{1-l, \dots, r-1\}$ and hence all of the neighbours of these vertices are in $\mathcal{V}_G(P_{l,r})$. Therefore \mathbf{v} is orthogonal to \mathbf{v}_j for all $j \in \{1-l, \dots, r-1\}$. If $l > 0$ and $r > 0$, then, in particular, the vertices v_0 and v'_0 are $P'_{l,r}$ -saturated in $P_{l,r}$. And Lemma 3.9 gives that \mathbf{v} is orthogonal to all of the vectors \mathbf{v}'_j for $j \in \{1-l, \dots, r-1\}$.

Suppose $l = 0$. We can assume $\langle \mathbf{v}, \mathbf{v}_0 \rangle = 1$. We must have that v is adjacent to v'_0 otherwise G would contain a subgraph equivalent to YA_3 . Moreover, the exclusion of XA_1 and YA_6 forces the inner product $\langle \mathbf{v}, \mathbf{v}'_0 \rangle = 1$. Thus, $\langle \mathbf{v}, \mathbf{v}_0 - \mathbf{v}'_0 \rangle = 0$. Applying Lemma 3.9 gives us that \mathbf{v} is also orthogonal to all of the vectors \mathbf{v}'_j , for $j \in \{1-l, \dots, r-1\}$. The argument is similar when $r = 0$. ■

Lemma 3.14 (Left/Right adjacency). *Let G be an \mathcal{L}_1 -free S -graph containing $P_{l,r}$ with $l+r > 2$, where a vertex $v \in V(G) \setminus \mathcal{V}_G(P_{l,r})$ is adjacent to v_{-l} and v_r . Then G is contained in a graph equivalent to either $T_{2(l+r+2)}$ or $T_{2(l+r+2)}^{(i)}$.*

Proof. We can assume that $\langle \mathbf{v}, \mathbf{v}_{-l} \rangle = 1$ and $\langle \mathbf{v}, \mathbf{v}_r \rangle = s$ for some nonzero $s \in S$. By Lemma 3.8, we can write

$$2\mathbf{v}_{1-l} = \mathbf{v}_{-l} - \mathbf{v}'_{-l} + \mathbf{v}_{2-l} + \mathbf{v}'_{2-l}. \quad (3.12)$$

By assumption $r > 2-l$, and so, according to Lemma 3.13, the Gram vector \mathbf{v} is orthogonal to \mathbf{v}_{1-l} , \mathbf{v}_{2-l} , and \mathbf{v}'_{2-l} . Taking the inner product of \mathbf{v} and equation (3.12) gives $\langle \mathbf{v}, \mathbf{v}'_{-l} \rangle = \langle \mathbf{v}, \mathbf{v}_{-l} \rangle = 1$. Again, by Lemma 3.8, we can write

$$2\mathbf{v}_{r-1} = \mathbf{v}_{r-2} - \mathbf{v}'_{r-2} + \mathbf{v}_r + \mathbf{v}'_r. \quad (3.13)$$

Similarly, \mathbf{v} is orthogonal to \mathbf{v}_{r-1} , \mathbf{v}_{r-2} , and \mathbf{v}'_{r-2} , and, from the inner product of \mathbf{v} and equation (3.13), we obtain $\langle \mathbf{v}, \mathbf{v}'_r \rangle = -\langle \mathbf{v}, \mathbf{v}_r \rangle = -s$. By Lemma 3.8, we write

$$2\mathbf{v} = s\mathbf{v}_r - s\mathbf{v}'_r + \mathbf{v}_{-l} + \mathbf{v}'_{-l}.$$

Define the vector \mathbf{v}' by the equation

$$2\mathbf{v}' = s\mathbf{v}_r - s\mathbf{v}'_r - \mathbf{v}_{-l} - \mathbf{v}'_{-l}. \quad (3.14)$$

Let v' be a hollow vertex of $P_{l,r} \cup \{v\}$ with Gram vector \mathbf{v}' . The graph $P'_{l,r} \cup \{v, v'\}$ is equivalent to one of the $\mathbb{Z}[i]$ -graphs T_{2k} or $T_{2k}^{(i)}$ (for $k = l+r+2$), and hence it too is cyclotomic.

Now we show that every vertex in $V(P_{l,r}) \cup \{v\}$ is $(P'_{l,r} \cup \{v, v'\})$ -saturated in $P_{l,r} \cup \{v\}$. By Lemma 3.10, this immediately reduces to showing that v_{-l} , v_r , and v are $(P'_{l,r} \cup \{v, v'\})$ -saturated in $P_{l,r} \cup \{v\}$.

First we show that v_{-l} is $(P'_{l,r} \cup \{v, v'\})$ -saturated in $P_{l,r} \cup \{v\}$. Suppose that a vertex $x \in V(G) \setminus V(P_{l,r} \cup \{v\})$ is adjacent to v_{-l} . We can assume that $\langle \mathbf{x}, \mathbf{v}_{-l} \rangle = -1$. We must have that x is adjacent to at least one of the vertices v_r and v_{2-l} , otherwise G would contain a subgraph equivalent to YA_3 . The exclusion of XA_1 , YA_2 , and YA_6 forces x to be adjacent to either v_r or v_{2-l} . If x is adjacent to v_{2-l} then, since v_{2-l} is $(P'_{l,r} \cup \{v, v'\})$ -saturated in $P_{l,r} \cup \{v\}$, the Gram vector \mathbf{x} must be switch-equivalent to \mathbf{v}'_{1-l} . Otherwise, we assume x is adjacent to v_r . If $\langle \mathbf{x}, \mathbf{v}_r \rangle = -s$ then G would contain a subgraph equivalent XA_1 and if $\langle \mathbf{x}, \mathbf{v}_r \rangle = \pm is$ then G would contain a subgraph equivalent to YA_6 . We have, therefore, that

$\langle \mathbf{x}, \mathbf{v}_r \rangle = s$. Apply Lemma 3.13, to give that, in particular, \mathbf{x} is orthogonal to the vectors \mathbf{v}_{1-l} , \mathbf{v}_{2-l} , \mathbf{v}'_{2-l} , \mathbf{v}_{r-1} , \mathbf{v}_{r-2} , and \mathbf{v}'_{r-2} . The inner product of \mathbf{x} with equation (3.13) and the inner product of \mathbf{x} with equation (3.12) yield $\langle \mathbf{x}, \mathbf{v}'_r \rangle = -s$ and $\langle \mathbf{x}, \mathbf{v}'_{-l} \rangle = -1$ respectively. Now, taking the inner product of \mathbf{x} with equation (3.14) gives $\mathbf{x} = \mathbf{v}'$. Hence, the vertex v_{-l} is $(P'_{l,r} \cup \{v, v'\})$ -saturated in $P_{l,r} \cup \{v\}$. Similar arguments show that v_r is also $(P'_{l,r} \cup \{v, v'\})$ -saturated in $P_{l,r} \cup \{v\}$.

It remains to show that v is $(P'_{l,r} \cup \{v, v'\})$ -saturated in $P_{l,r} \cup \{v\}$. Suppose that a vertex $x \in V(G) \setminus (V(P_{l,r}) \cup \{v\})$ is adjacent to v . Since triangles have been excluded, x is adjacent to neither v_{-l} nor v_r . In fact, we must have that x is adjacent to either v_{1-l} or v_{r-1} otherwise G would contain a subgraph equivalent to YA_3 . Both v_{1-l} and v_{r-1} are $(P'_{l,r} \cup \{v, v'\})$ -saturated in $P_{l,r} \cup \{v\}$, so we are done.

Since $P'_{l,r} \cup \{v, v'\}$ is $(P'_{l,r} \cup \{v, v'\})$ -saturated in $P_{l,r} \cup \{v\}$, each vertex of G corresponds to a vertex of $P'_{l,r} \cup \{v, v'\}$. This correspondence is one to one, since otherwise, if two vertices x and y of G were both switch-equivalent to the same vertex z , then $|w(x, y)| = 2$, which would contradict the fact that $\mathfrak{S}w \subseteq S$. Depending on the value of s , the S -graph $P'_{l,r} \cup \{v, v'\}$ is either $T_{2(l+r+2)}$ or $T_{2(l+r+2)}^{(i)}$. Hence G is contained in a graph equivalent to either $T_{2(l+r+2)}$ or $T_{2(l+r+2)}^{(i)}$. ■

3.3.3 \mathcal{L}_1 -free S -graphs on up to 9 vertices

Consider the infinite family of n -vertex ($n \geq 3$) S -cycles $O_n^{(s)}$ illustrated below.

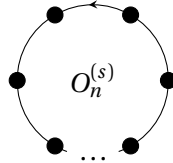

The edge of $O_n^{(s)}$ marked with an arrow corresponds to the edge of weight s . The S -cycles $O_n^{(s)}$ can be defined on vertices v_1, \dots, v_n by setting $w(v_1, v_n) = s$ for some $s \in S$ and $w(v_j, v_{j+1}) = 1$ for $j \in \{1, \dots, n-1\}$.

Lemma 3.15. *The S -graph $O_n^{(s)}$ is cyclotomic for all $n \geq 3$.*

Proof (a quick proof). Since $O_n^{(s)}$ is contained in either T_{2k} or $T_{2k}^{(i)}$, which are both cyclotomic, the lemma follows by Theorem 1.6. ■

Proof (an alternative proof). Let

$$A^{(s)} = \begin{pmatrix} 0 & 1 & 0 & \dots & 0 & 1 \\ 1 & 0 & 1 & & & 0 \\ 0 & 1 & 0 & 1 & & \\ \vdots & & 1 & \ddots & 1 & \vdots \\ & & & & 1 & 0 & 1 & 0 \\ 0 & & & & 1 & 0 & s \\ 1 & 0 & & \dots & 0 & \bar{s} & 0 \end{pmatrix}$$

be an adjacency matrix of $O_n^{(s)}$. Let $\mathbf{v}_1, \dots, \mathbf{v}_n \in \mathbb{C}^n$ be constructed as follows:

$$\begin{aligned} \mathbf{v}_1^T &= (1, 1, 0, \dots, 0) \\ \mathbf{v}_2^T &= (0, 1, 1, 0, \dots, 0) \\ &\vdots \\ \mathbf{v}_{n-1}^T &= (0, \dots, 0, 1, 1) \\ \mathbf{v}_n^T &= (1, 0, \dots, 0, s). \end{aligned}$$

Setting $B^T = (\mathbf{v}_1, \dots, \mathbf{v}_n)$ gives $BB^* = A^{(s)} + 2I$. Hence $A^{(s)} + 2I$ is positive semidefinite. Therefore the smallest eigenvalue of $A^{(s)}$ must be at least -2 for all $s \in \{\pm 1, \pm i\}$. Moreover, it is easy to see that $-A^{(s)}$ is strongly equivalent to $A^{(t)}$ for some $t \in \{\pm 1, \pm i\}$. Hence the eigenvalues of $A^{(s)}$ must be contained inside the interval $[-2, 2]$. ■

Lemma 3.16. *Let G be an uncharged S -cycle. Then G is strongly equivalent to $O_n^{(s)}$ for some $s \in \{\pm 1, \pm i\}$ and some $n \in \mathbb{N}$.*

Proof. Suppose G is an S -cycle on n vertices. Label the vertices v_1, \dots, v_n so that v_1 is adjacent to v_n and v_j is adjacent to v_{j+1} for all $j \in \{1, \dots, n-1\}$. We can inductively switch the vertices of G so that $w(v_j, v_{j+1}) = 1$ for all $j \in \{1, \dots, n-1\}$, and $w(v_1, v_n) = s$ for some $s \in \{\pm 1, \pm i\}$. ■

Let G be an \mathcal{L}_1 -free S -graph. If the maximum degree of G is 1 then G is just an edge. If the maximum degree of G is 2, then G is either an S -cycle or an S -path. If G is an S -path then by inductively switching the vertices, we obtain an equivalent $\{0, 1\}$ -path which is contained in the visibly cyclotomic \mathbb{Z} -graph T_{2k} for some k . If G is an S -cycle then, by Lemma 3.16, G is equivalent to the S -cycle $O_n^{(s)}$ in Lemma 3.15 for some $s \in \{\pm 1, \pm i\}$. The problem, therefore, reduces to assuming that the maximum degree of G is at least 3.

Below we describe the process of computing \mathcal{L}_1 -free S -graphs on a given number of vertices.

Growing process. Start with a single vertex H . Consider all possible ways of adding a vertex to H such that the resulting graph H' is \mathcal{L}_1 -free. Repeat this process with all supergraphs H' until all \mathcal{L}_1 -free S -graphs on the desired number of vertices have been obtained.

We have exhaustively computed (up to equivalence) all \mathcal{L}_1 -free S -graphs on up to 9 vertices having maximal degree at least 3. Out of these graphs, the ones on 9 vertices contained a subgraph equivalent to either $P_{0,3}$ or $P_{1,2}$. It should be noted that this computation can be done by hand. One considers all \mathcal{L}_1 -free S -supergraphs of the complete bipartite graph $K_{1,3}$ that do not contain a graph equivalent to $P_{l,r}$, with $l+r > 2$, to find that there do not exist any such graphs on more than 8 vertices. For the sake of succinctness we have omitted the details.

Now, from the above computation and by iteratively applying Lemmata 3.11, 3.12, and 3.14, we have the following lemma.

Lemma 3.17. *Let G be an \mathcal{L}_1 -free S -graph. Then G is contained in either T_{2k} or $T_{2k}^{(i)}$ for $k \geq 3$.*

Together with the computation of the maximal connected cyclotomic $\mathbb{Z}[i]$ -graphs containing the excluded subgraphs of type II from the list \mathcal{L}_1 (see Figure 3.10), we have proved Theorem 3.1.

3.4 Proof of Theorem 3.2

In this section we prove Theorem 3.2. Let G be an uncharged cyclotomic $\mathbb{Z}[i]$ -graph. By Corollary 1.8, we know that G cannot be equivalent to a graph containing any weight- α edge where the norm of α is greater than 4. Therefore G can have edge-weights coming only from the subset

$$\{0, \pm 1, \pm i, \pm 1 \pm i, \pm 2, \pm 2i\}.$$

3.4.1 Excluded subgraphs

In Table 3.4 we list each excluded subgraph of type II in Figure 3.12 along with every maximal connected cyclotomic $\mathbb{Z}[i]$ -graph that contains it. Let \mathcal{L}_2 consist of all cyclotomic

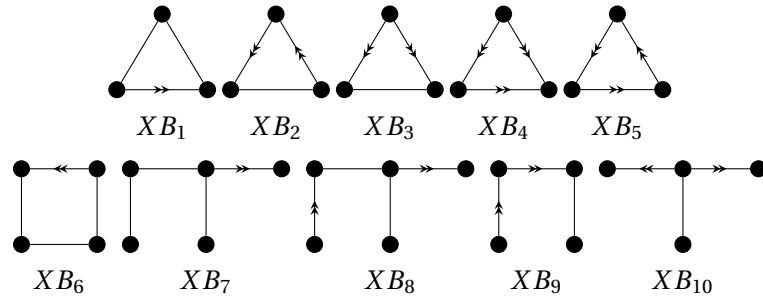

Figure 3.11: some non-cyclotomic uncharged $\mathbb{Z}[i]$ -graphs.

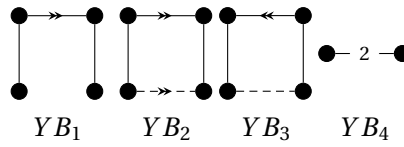

Figure 3.12: some cyclotomic $\mathbb{Z}[i]$ -graphs that are contained as subgraphs of fixed maximal connected cyclotomic $\mathbb{Z}[i]$ -graphs.

Excluded subgraph	Maximal cyclotomics
YB_1	S_8^+
YB_2	S_8^+
YB_3	S_8^{++}
YB_4	S_2

Table 3.4: Excluded subgraphs from Figure 3.12 and (up to equivalence) their containing maximal connected cyclotomic $\mathbb{Z}[i]$ -graphs.

charged vertices and the graphs in Figures 3.10 and 3.12. Hence, all \mathcal{L}_2 -free $\mathbb{Z}[i]$ -graphs are uncharged and, since we have excluded $XB_1, XB_2, XB_3, XB_4, XB_5$ together with YA_4 and YA_5 , we have that no \mathcal{L}_2 -free $\mathbb{Z}[i]$ -graph can contain a subgraph whose underlying subgraph is a triangle. As in Section 3.3, we may refer to this fact as the ‘exclusion of triangles’. For this section, the notion of a saturated vertex will depend on the list \mathcal{L}_2 .

3.4.2 Inductive lemmata

Define P_{2r+1} (solid vertices) and P'_{2r+1} (solid vertices and hollow vertices) with the following $\mathbb{Z}[i]$ -graph

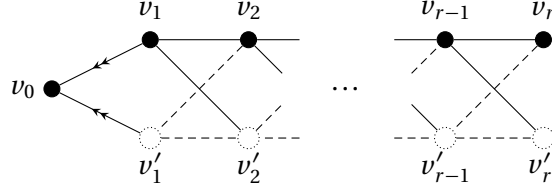

where $r \geq 1$. The set of hollow vertices of P_{2r+1} is the set $V(P'_{2r+1}) \setminus V(P_{2r+1})$. Clearly both P_{2r+1} and P'_{2r+1} are cyclotomic since they are contained in $C_{2(r+1)}$. Note that P_{2r+1} has $r+1$ vertices and P'_{2r+1} has $2r+1$ vertices. Having chosen Gram vectors $\mathbf{v}_0, \dots, \mathbf{v}_r$, by an argument similar to the proof of Lemma 3.8, we can write

$$\mathbf{v}'_1 = -\mathbf{v}_1 + (1+i)\mathbf{v}_0 \quad (3.15)$$

and

$$\mathbf{v}'_2 = -\mathbf{v}_2 + 2\mathbf{v}_1 - (1+i)\mathbf{v}_0. \quad (3.16)$$

Lemma 3.18. *In P_{2r+1} for $r \geq 2$, we can write the Gram vector for each hollow vertex in terms of Gram vectors of the vertices as follows:*

$$\mathbf{v}'_t = -\mathbf{v}_t - 2 \sum_{j=1}^{t-1} (-1)^{t+j} \mathbf{v}_j - (-1)^t (1+i)\mathbf{v}_0, \quad \text{for } t \in \{1, \dots, r\}.$$

Proof. If $r = 2$, then, since we have equation (3.15) and equation (3.16) there is nothing to prove. Therefore we assume that $r > 2$. By Lemma 3.8, for $k \in \{2, \dots, r-1\}$, we can write

$$2\mathbf{v}_k = \mathbf{v}_{k+1} + \mathbf{v}'_{k+1} + \mathbf{v}_{k-1} - \mathbf{v}'_{k-1}. \quad (3.17)$$

Suppose the vectors \mathbf{v}'_t have the required form for all $t \leq k$ so that, in particular,

$$\mathbf{v}'_{k-1} = -\mathbf{v}_{k-1} - 2 \sum_{j=1}^{k-2} (-1)^{k-1+j} \mathbf{v}_j - (-1)^{k-1} (1+i)\mathbf{v}_0. \quad (3.18)$$

Rearranging equation (3.17) and substituting equation (3.18) gives

$$\mathbf{v}'_{k+1} = -\mathbf{v}_{k+1} - 2 \sum_{j=1}^k (-1)^{k+1+j} \mathbf{v}_j - (-1)^{k+1} (1+i)\mathbf{v}_0.$$

By equation (3.15) and equation (3.16) the vectors \mathbf{v}'_1 and \mathbf{v}'_2 have the required form. Hence, by induction, so too do the vectors \mathbf{v}'_t for all $t \in \{1, \dots, r\}$. \blacksquare

Lemma 3.19 (Saturated vertices). *Let G be an \mathcal{L}_2 -free $\mathbb{Z}[i]$ -graph containing P_{2r+1} with $r \geq 3$. Then, for each vertex $v \in V'_4(P_{2r+1})$, we have $N_G(v) = N'_G(v)$. Hence, each vertex in $V'_4(P_{2r+1})$ is P'_{2r+1} -saturated in P_{2r+1} .*

Proof. Fix Gram vectors for P'_{2r+1} . We want to show that, for all vertices $v \in V'_4(P_{2r+1})$, we have $N_G(v) = N'_G(v)$. Since P'_{2r+1} contains P_{2r+1} , we have $N_G(v) \cap V(P_{2r+1}) = N'_G(v) \cap V(P_{2r+1})$ for all vertices $v \in V(G)$. Hence, we consider a vertex $v \in V(G) \setminus V(P_{2r+1})$. Suppose that v is adjacent to the vertex $v_j \in V'_4(P_{2r+1})$ for some $j \in \{0, \dots, r-1\}$. Without loss of generality, either $\langle \mathbf{v}, \mathbf{v}_j \rangle = 1$ or $\langle \mathbf{v}, \mathbf{v}_j \rangle = 1 + i$.

Suppose first that $j = 0$. The exclusion of triangles implies that $\langle \mathbf{v}, \mathbf{v}_1 \rangle = 0$. Since XB_9 and YB_1 are excluded, v must be adjacent to v_2 , moreover, the excluded subgraphs XB_6 and YB_3 preclude the possibility of $\langle \mathbf{v}, \mathbf{v}_0 \rangle = 1$ while $\langle \mathbf{v}, \mathbf{v}_2 \rangle = \pm 1$. And since $r \geq 3$, if both $\langle \mathbf{v}, \mathbf{v}_0 \rangle = 1$ while $\langle \mathbf{v}, \mathbf{v}_2 \rangle = \pm 1 \pm i$ then G would contain a subgraph equivalent to YB_1 . Therefore we must have $\langle \mathbf{v}, \mathbf{v}_0 \rangle = 1 + i$. By taking the inner product of \mathbf{v} and equation (3.15), we obtain that $\mathbf{v} = \mathbf{v}'_1$.

Second, suppose that $j = 1$. Since we have excluded triangles, \mathbf{v} must be orthogonal to both \mathbf{v}_0 and \mathbf{v}_2 and we must have $\langle \mathbf{v}, \mathbf{v}_1 \rangle = 1$, otherwise the degree of v_1 is greater than 4. Using equation (3.16), we find that $\langle \mathbf{v} - \mathbf{v}'_2, \mathbf{v} - \mathbf{v}'_2 \rangle = 0$. Hence $\mathbf{v} = \mathbf{v}'_2$.

We have that the vertices v_0 and v_1 are P'_{2r+1} -saturated in P_{2r+1} . We assume that, for $1 < t < r$, each vertex $v_j \in V'_4(P_{2r+1})$ with $0 \leq j < t$ is P'_{2r+1} -saturated in P_{2r+1} . It suffices now to show that v_t is P'_{2r+1} -saturated in P_{2r+1} . Suppose a vertex $v \in V(G) \setminus V(P_{2r+1})$ is adjacent to v_t . We split into cases.

Case 1. v is adjacent to v_{t-2} . By our inductive hypothesis, v_{t-2} is P'_{2r+1} -saturated in P_{2r+1} and thus \mathbf{v} is switch-equivalent to the Gram vector of some hollow vertex. Moreover, the hollow vertex in question must be adjacent to both v_t and v_{t-2} . Hence \mathbf{v} is switch-equivalent to \mathbf{v}'_{t-1} .

Case 2. v is not adjacent to v_{t-2} . Then $\langle \mathbf{v}, \mathbf{v}_{t-2} \rangle = 0$. Since triangles are excluded, \mathbf{v} is orthogonal to \mathbf{v}_{t-1} and \mathbf{v}_{t+1} . And we must have $\langle \mathbf{v}, \mathbf{v}_t \rangle = 1$ since we have excluded XB_7 and XB_8 . Now, our inductive hypothesis says that if v is adjacent to a vertex $v_k \in V'_4(P_{2r+1})$ where $0 \leq k < t$ then \mathbf{v} is switch-equivalent to the Gram vector of some hollow vertex. But for $0 \leq k \leq t-3$ there are no hollow vertices adjacent to both v_k and v_t . Therefore \mathbf{v} must be orthogonal to all of $\mathbf{v}_0, \mathbf{v}_1, \dots, \mathbf{v}_{t-3}$. By Lemma 3.9, the vector \mathbf{v}'_{t-1} is a linear combination of the Gram vectors $\mathbf{v}_0, \mathbf{v}_1, \dots, \mathbf{v}_{t-1}$, and hence $\langle \mathbf{v}'_{t-1}, \mathbf{v} \rangle = 0$. By Lemma 3.8

we can write

$$2\mathbf{v}_t = \mathbf{v}_{t-1} - \mathbf{v}'_{t-1} + \mathbf{v}_{t+1} + \mathbf{v}'_{t+1}. \quad (3.19)$$

From the inner product of \mathbf{v} and equation (3.19), it follows that $\mathbf{v} = \mathbf{v}'_{t+1}$ as required. ■

Let G be an \mathcal{L}_2 -free $\mathbb{Z}[i]$ -graph containing P_{2r+1} with $r \geq 3$. By the symmetry of P'_{2r+1} , it follows from Lemma 3.19 that each vertex in $V'_4(\mathcal{V}_G(P_{2r+1}))$ is P'_{2r+1} -saturated in $\mathcal{V}_G(P_{2r+1})$.

Lemma 3.20. *Let G be an \mathcal{L}_2 -free $\mathbb{Z}[i]$ -graph containing P_{2r+1} with $r \geq 3$, where v_r is adjacent to a vertex $v \in V(G) \setminus \mathcal{V}_G(P_{2r+1})$. Then either G is contained in $C_{2(r+1)}$ or G contains $P_{2(r+1)+1}$.*

Proof. Without loss of generality, we have either $\langle \mathbf{v}, \mathbf{v}_r \rangle = 1$ or $\langle \mathbf{v}, \mathbf{v}_r \rangle = 1 + i$. By Lemma 3.18, for $j \in \{1, \dots, r-1\}$, we can write \mathbf{v}'_j as a linear combination of the Gram vectors $\mathbf{v}_0, \dots, \mathbf{v}_j$. According to Lemma 3.19, the vertices v_0, \dots, v_{r-1} are P'_{2r+1} -saturated in P_{2r+1} . Since $v \notin \mathcal{V}_G(P_{2r+1})$, we have $\langle \mathbf{v}, \mathbf{v}_j \rangle = 0$ for $j \in \{0, \dots, r-1\}$. Therefore, \mathbf{v} is orthogonal to \mathbf{v}'_j for all $j \in \{1, \dots, r-1\}$. Hence, in particular, \mathbf{v} is orthogonal to \mathbf{v}_{r-1} , \mathbf{v}_{r-2} , and \mathbf{v}'_{r-2} . By Lemma 3.8 we have

$$2\mathbf{v}_{r-1} = \mathbf{v}_{r-2} - \mathbf{v}'_{r-2} + \mathbf{v}_r + \mathbf{v}'_r. \quad (3.20)$$

Take the inner product of \mathbf{v} and equation (3.20) to give $\langle \mathbf{v}, \mathbf{v}_r \rangle = -\langle \mathbf{v}, \mathbf{v}'_r \rangle$.

Case 1. $\langle \mathbf{v}, \mathbf{v}_r \rangle = 1 + i$. By above, we have $\langle \mathbf{v}, \mathbf{v}'_r \rangle = -1 - i$. Hence, the graph $P'_{2r+1} \cup \{v\}$ is equal to the visibly cyclotomic $\mathbb{Z}[i]$ -graph $C_{2(r+1)}$, and hence it too is cyclotomic.

It remains to show that every vertex of $V(P_{2r+1}) \cup \{v\}$ is $(P'_{2r+1} \cup \{v\})$ -saturated in $P_{2r+1} \cup \{v\}$. By Lemma 3.19, this immediately reduces to showing that both v and v_r are $(P'_{2r+1} \cup \{v\})$ -saturated in $P_{2r+1} \cup \{v\}$.

First we treat v . Suppose a vertex $x \in V(G) \setminus V(P_{2r+1} \cup \{v\})$ is adjacent to v . The exclusion of triangles and the excluded subgraphs XB_9 and YB_1 force x to be adjacent to the vertex v_{r-1} which is $(P'_{2r+1} \cup \{v\})$ -saturated in $P_{2r+1} \cup \{v\}$. Therefore \mathbf{x} is switch-equivalent to \mathbf{v}'_r .

It remains to show that v_r is $(P'_{2r+1} \cup \{v\})$ -saturated in $P_{2r+1} \cup \{v\}$. Suppose that $x \in V(G) \setminus V(P_{2r+1} \cup \{v\})$ is adjacent to v_r . Since all possible uncharged triangles have been excluded, we have that \mathbf{x} is orthogonal to both \mathbf{v}_{r-1} and \mathbf{v} . And the excluded subgraphs XB_7 and XB_{10} force x to be adjacent to the vertex v_{r-2} which is $(P'_{2r+1} \cup \{v\})$ -saturated in $P_{2r+1} \cup \{v\}$. Therefore \mathbf{x} is switch-equivalent to \mathbf{v}'_{r-1} . We have shown that both v and v_r are $(P'_{2r+1} \cup \{v\})$ -saturated in $P_{2r+1} \cup \{v\}$.

Since each vertex of $P'_{2r+1} \cup \{v\}$ is $(P'_{2r+1} \cup \{v\})$ -saturated in $P_{2r+1} \cup \{v\}$, the vertices of G correspond to vertices of $P'_{2r+1} \cup \{v\}$. This correspondence is one to one, since otherwise, if two vertices x and y of G were both switch-equivalent to the same vertex z , then $|\langle \mathbf{x}, \mathbf{y} \rangle| = 2$, and YB_4 has been excluded. Since $P'_{2r+1} \cup \{v\}$ is equal to $C_{2(r+1)}$, G is equivalent to a subgraph of $C_{2(r+1)}$.

Case 2. $\langle \mathbf{v}, \mathbf{v}_r \rangle = 1$. By above, we have $\langle \mathbf{v}, \mathbf{v}'_r \rangle = -1$. We have established a subgraph of G equivalent to $P_{2(r+1)+1}$. ■

3.4.3 \mathcal{L}_2 -free $\mathbb{Z}[i]$ -graphs on up to 7 vertices

Let G be an \mathcal{L}_2 -free $\mathbb{Z}[i]$ -graph. If G does not contain an edge with a weight of norm at least 2 then G has been classified in Theorem 3.1. Since G is cyclotomic, it cannot be equivalent to a graph containing an edge of norm greater than 4. We have excluded YB_4 and no element of $\mathbb{Z}[i]$ has norm 3, so we can assume that G contains an edge of norm 2. The growing process is similar to that described in Section 3.3.3, but in this case we can start the process with a weight- $(1+i)$ edge. From this process, we have exhaustively computed (up to equivalence) all \mathcal{L}_2 -free $\mathbb{Z}[i]$ -graphs on up to 7 vertices. Out of these graphs, each one on 7 vertices contains a subgraph equivalent to P_7 (4 vertices). Again, we note that this computation can be done by hand.

From the above computation and by iteratively applying Lemma 3.20 we have the following lemma.

Lemma 3.21. *Let G be an \mathcal{L}_2 -free $\mathbb{Z}[i]$ -graph having at least one edge-weight of norm 2. Then G is equivalent to a subgraph of C_{2k} for some $k \geq 2$.*

Together with the computation of the maximal connected cyclotomic $\mathbb{Z}[i]$ -graphs containing the excluded subgraphs of type II from the list \mathcal{L}_2 (see Figure 3.12), we have proved Theorem 3.2.

3.5 Proof of Theorem 3.3

In this section we prove Theorem 3.3. Let G be a cyclotomic $\mathbb{Z}[i]$ -graph. As in Section 3.4, G can have edge-weights coming only from the set

$$\{0, \pm 1, \pm i, \pm 1 \pm i, \pm 2, \pm 2i\}.$$

Moreover, since we are actually studying Hermitian matrices, we allow G to contain only rational integer charges, and by Corollary 1.8, this immediately restricts the charges to coming from the set $\{0, \pm 1, \pm 2\}$.

3.5.1 Excluded subgraphs

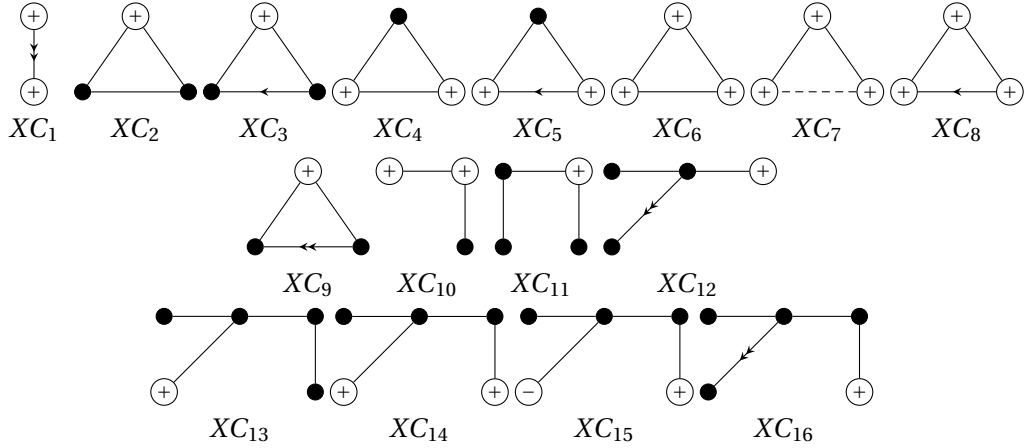

Figure 3.13: some non-cyclotomic charged $\mathbb{Z}[i]$ -graphs.

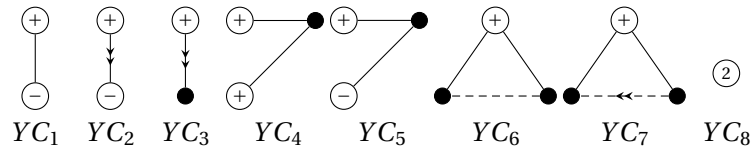
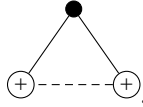

Figure 3.14: some charged cyclotomic $\mathbb{Z}[i]$ -graphs that are contained as subgraphs of fixed maximal connected cyclotomic $\mathbb{Z}[i]$ -graphs.

Excluded subgraph	Maximal cyclotomics
YC_1	$C_4^{+-}, S_4, S_4^{\dagger}, S_7, S_8,$ and S_8'
YC_2	S_4
YC_3	C_3
YC_4	C_6^{++} and S_7
YC_5	C_6^{+-} and S_8'
YC_6	S_7 and S_8'
YC_7	S_4^{\dagger}
YC_8	S_1

Table 3.5: Excluded subgraphs from Figure 3.14 and (up to equivalence) their containing maximal connected cyclotomic $\mathbb{Z}[i]$ -graphs.

In Table 3.5 we list each excluded subgraph of type II in Figure 3.14 along with every maximal connected cyclotomic $\mathbb{Z}[i]$ -graph that contains it. Let \mathcal{L}_3 consist of the excluded subgraphs of type II in Figures 3.10, 3.12, and 3.14. Note that, up to equivalence, there is exactly one charged $\mathbb{Z}[i]$ -triangle that *can* be a subgraph of an \mathcal{L}_3 -free $\mathbb{Z}[i]$ -graph, namely the triangle



In this section, the notion of a saturated vertex will depend on the list \mathcal{L}_3 .

3.5.2 Inductive lemmata

Define P_{2r} and P'_{2r} with the following \mathbb{Z} -graph

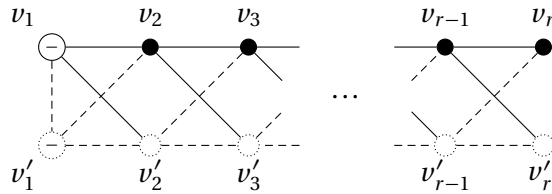

where $r \geq 1$. Here, the set of hollow vertices of P_{2r} is the set $V(P'_{2r}) \setminus V(P_{2r})$. Clearly both P_{2r} and P'_{2r} are cyclotomic since they are contained in a \mathbb{Z} -graph equivalent to $C_{2(r+1)}^{++}$. Having chosen Gram vectors $\mathbf{v}_1, \dots, \mathbf{v}_r$, by an argument similar to Lemma 3.8, we can write

$$\mathbf{v}'_1 = -\mathbf{v}_1; \tag{3.21}$$

$$\mathbf{v}'_2 = -\mathbf{v}_2 + 2\mathbf{v}_1; \tag{3.22}$$

and

$$\mathbf{v}'_3 = -\mathbf{v}_3 + 2\mathbf{v}_2 - 2\mathbf{v}_1. \tag{3.23}$$

Lemma 3.22. *In P_{2r} for $r \geq 3$, we can write the Gram vector for each hollow vertex in terms of Gram vectors of the vertices as follows:*

$$\mathbf{v}'_t = -\mathbf{v}_t - 2 \sum_{j=1}^{t-1} (-1)^{t+j} \mathbf{v}_j, \quad \text{for } t \in \{1, \dots, r\}.$$

Proof. If $r = 3$, then, since we have equation (3.21), equation (3.22), and equation (3.23) there is nothing to prove. Therefore we assume that $r > 3$. Let $k \in \{3, \dots, r-1\}$. By

Lemma 3.8, we can write

$$2\mathbf{v}_k = \mathbf{v}_{k+1} + \mathbf{v}'_{k+1} + \mathbf{v}_{k-1} - \mathbf{v}'_{k-1}. \quad (3.24)$$

Suppose the lemma holds for all $t \leq k$ so that, in particular,

$$\mathbf{v}'_{k-1} = -\mathbf{v}_{k-1} - 2 \sum_{j=1}^{k-2} (-1)^{k-1+j} \mathbf{v}_j. \quad (3.25)$$

Rearranging equation (3.24) and substituting equation (3.25) gives

$$\mathbf{v}'_{k+1} = -\mathbf{v}_{k+1} - 2 \sum_{j=1}^k (-1)^{k+1+j} \mathbf{v}_j.$$

By equation (3.21) and equation (3.22) the lemma holds for \mathbf{v}'_1 and \mathbf{v}'_2 , hence the lemma holds for all $t \in \{1, \dots, r\}$ by induction. \blacksquare

Lemma 3.23 (Saturated vertices). *Let G be an \mathcal{L}_3 -free $\mathbb{Z}[i]$ -graph containing P_{2r} with $r \geq 3$. Then, for each vertex $v \in V'_4(P_{2r})$, we have $N_G(v) = N'_G(v)$. Hence, each vertex in $V'_4(P_{2r})$ is P'_{2r} -saturated in P_{2r} .*

Proof. Fix Gram vectors for P'_{2r} . We want to show that, for all vertices $v \in V'_4(P_{2r})$, we have $N_G(v) = N'_G(v)$. Since P'_{2r} contains P_{2r} , we have $N_G(v) \cap V(P_{2r}) = N'_G(v) \cap V(P_{2r})$ for all vertices $v \in V(G)$. Hence, we consider a vertex $v \in V(G) \setminus V(P_{2r})$. Suppose that v is adjacent to the vertex $v_j \in V'_4(P_{2r})$ for some $j \in \{1, \dots, r-1\}$. Without loss of generality, either $\langle \mathbf{v}, \mathbf{v}_j \rangle = 1$ or $\langle \mathbf{v}, \mathbf{v}_j \rangle = 1 + i$.

Suppose first that $j = 1$. If v is charged, then the excluded subgraphs YC_2 and XC_1 rule out the possibility of $\langle \mathbf{v}, \mathbf{v}_1 \rangle = 1 + i$, and so we assume $\langle \mathbf{v}, \mathbf{v}_1 \rangle = 1$. Moreover, YC_1 forces v to have charge -1 . Therefore the inner product $\langle \mathbf{v} + \mathbf{v}'_1, \mathbf{v} + \mathbf{v}'_1 \rangle$ is zero and hence $\mathbf{v} = -\mathbf{v}'_1$. On the other hand, if v is uncharged, then the excluded subgraph YC_3 rules out the possibility of $\langle \mathbf{v}, \mathbf{v}_1 \rangle = 1 + i$, and so we assume $\langle \mathbf{v}, \mathbf{v}_1 \rangle = 1$. The exclusion of the triangles containing exactly one charged vertex XC_2 , XC_3 , and YC_6 forces \mathbf{v} to be orthogonal to \mathbf{v}_2 and by taking the inner product of \mathbf{v} and equation (3.22) we find that $\mathbf{v} = \mathbf{v}'_2$. Hence, the vertex v_1 is P'_{2r} -saturated in P_{2r} .

Now suppose that $j = 2$. If v is adjacent to v_1 , then, since v_1 is P'_{2r} -saturated in P_{2r} and v'_1 is adjacent to v_2 , we must have \mathbf{v} switch-equivalent to \mathbf{v}'_1 . Otherwise, if v is not adjacent to v_1 , the excluded subgraphs YC_3 , YC_4 , and YC_5 imply that v is uncharged. Moreover, XB_1 , XB_2 , XB_3 , and XC_{12} rule out the possibility of $\langle \mathbf{v}, \mathbf{v}_2 \rangle = 1 + i$, so we assume

$\langle \mathbf{v}, \mathbf{v}_2 \rangle = 1$. The exclusion of uncharged triangles YA_4 and YA_5 forces $\langle \mathbf{v}, \mathbf{v}_3 \rangle = 0$ and using equation (3.23), we deduce that $\langle \mathbf{v} - \mathbf{v}'_3, \mathbf{v} - \mathbf{v}'_3 \rangle = 0$. Hence $\mathbf{v} = \mathbf{v}'_3$.

Thus v_1 and v_2 are P'_{2r} -saturated in P_{2r} . If $r = 3$, we are done, hence let $r > 3$. We assume that, for $2 < t < r$, each vertex $v_j \in V'_4(P_{2r})$ with $1 \leq j < t$ is P'_{2r} -saturated in P_{2r} . It suffices now to show that v_t is P'_{2r} -saturated in P_{2r} . Suppose a vertex $v \in V(G) \setminus V(P_{2r})$ is adjacent to v_t . We split into cases.

Case 1. v is adjacent to v_{t-2} . By our inductive hypothesis, v_{t-2} is P'_{2r} -saturated in P_{2r} and thus \mathbf{v} is switch-equivalent to the Gram vector of some hollow vertex. Moreover, the hollow vertex in question must be adjacent to both v_t and v_{t-2} . Hence \mathbf{v} is switch-equivalent to \mathbf{v}'_{t-1} .

Case 2. v is not adjacent to v_{t-2} . Since we have excluded triangles having at most one charge, v is adjacent to neither v_{t-1} nor v_{t+1} . If $t = 3$ then the excluded subgraphs XC_{14} , XC_{15} , and YC_3 preclude the possibility of v having a charge and the exclusion of XC_{16} means that we can assume $\langle \mathbf{v}, \mathbf{v}_t \rangle = 1$. Otherwise, if $t > 3$ then the excluded subgraphs XB_7 , XC_{13} , and YC_3 enable us to assume that v is uncharged and $\langle \mathbf{v}, \mathbf{v}_t \rangle = 1$. Hence, since $t \geq 3$, we can assume that v is uncharged and $\langle \mathbf{v}, \mathbf{v}_t \rangle = 1$. If $t = 3$ then, by Lemma 3.22, since \mathbf{v} is orthogonal to both $\mathbf{v}_1 = \mathbf{v}_{t-2}$ and $\mathbf{v}_2 = \mathbf{v}_{t-1}$ the Gram vector v is also orthogonal to \mathbf{v}'_{t-1} . Suppose that $t > 3$. If v were adjacent to v_j for some $j \in \{1, \dots, t-3\}$ then, by our inductive hypothesis, \mathbf{v} would be equivalent to the vector corresponding to some hollow vertex adjacent to v_j . But, since no hollow vertices are simultaneously adjacent to both v_t and v_j with $j \in \{1, \dots, t-3\}$, the Gram vector \mathbf{v} must be orthogonal to \mathbf{v}_j for all $j \in \{1, \dots, t-3\}$. Therefore, by Lemma 3.22, we have $\langle \mathbf{v}, \mathbf{v}'_{t-1} \rangle = 0$. Appealing to Lemma 3.8, write

$$2\mathbf{v}_t = \mathbf{v}_{t-1} - \mathbf{v}'_{t-1} + \mathbf{v}_{t+1} + \mathbf{v}'_{t+1}. \quad (3.26)$$

By taking the inner product of \mathbf{v} and equation (3.26) we find that $\mathbf{v} = \mathbf{v}'_{t+1}$. As required. ■

Let G be an \mathcal{L}_3 -free $\mathbb{Z}[i]$ -graph containing P_{2r} with $r \geq 3$. By the symmetry of P'_{2r} , it follows from Lemma 3.23 that each vertex in $V'_4(\mathcal{V}_G(P_{2r}))$ is P'_{2r} -saturated in $\mathcal{V}_G(P_{2r})$.

Lemma 3.24. *Let G be an \mathcal{L}_3 -free $\mathbb{Z}[i]$ -graph containing P_{2r} with $r \geq 3$, where v_r is adjacent to a vertex $v \in V(G) \setminus \mathcal{V}_G(P_{2r})$. Then \mathbf{v} is orthogonal to the vectors \mathbf{v}_j , and \mathbf{v}'_j , for $j \in \{1, \dots, r-1\}$.*

Proof. By Lemma 3.23, the vertices v_1, \dots, v_{r-1} are P'_{2r} -saturated in P_{2r} . Since $v \notin \mathcal{V}_G(P_{2r})$, the Gram vector \mathbf{v} is orthogonal to \mathbf{v}_j for all $j \in \{0, \dots, r-1\}$. For each $j \in \{1, \dots, r-1\}$, we can write \mathbf{v}'_j as a linear combination of the Gram vectors $\mathbf{v}_1, \dots, \mathbf{v}_j$ as in Lemma 3.22. Hence we have the result. ■

Lemma 3.25. *Let G be an \mathcal{L}_3 -free $\mathbb{Z}[i]$ -graph containing P_{2r} with $r \geq 3$ where v_r is adjacent to an uncharged vertex $v \in V(G) \setminus \mathcal{V}_G(P_{2r})$. Then either G is contained in C_{2r+1} or G contains $P_{2(r+1)}$.*

Proof. Similar to the proof of Lemma 3.20. ■

Lemma 3.26. *Let G be an \mathcal{L}_3 -free $\mathbb{Z}[i]$ -graph containing P_{2r} with $r \geq 3$ where v_r is adjacent to a charged vertex $v \in V(G) \setminus \mathcal{V}_G(P_{2r})$. Then G is contained in either $C_{2(r+1)}^{++}$ or $C_{2(r+1)}^{+-}$.*

Proof. Since we have excluded YC_3 , we can assume that $\langle \mathbf{v}, \mathbf{v}_r \rangle = 1$. By Lemma 3.8 we have

$$2\mathbf{v}_{r-1} = \mathbf{v}_{r-2} - \mathbf{v}'_{r-2} + \mathbf{v}_r + \mathbf{v}'_r. \quad (3.27)$$

By Lemma 3.24, \mathbf{v} is orthogonal to \mathbf{v}_{r-1} , \mathbf{v}_{r-2} , and \mathbf{v}'_{r-2} . Take the inner product of \mathbf{v} and equation (3.27) to give $\langle \mathbf{v}, \mathbf{v}_r \rangle = -\langle \mathbf{v}, \mathbf{v}'_r \rangle$. We split into cases when v has charge 1 and -1 respectively.

Case 1. Suppose that v has charge 1. We can write \mathbf{v} in terms of \mathbf{v}_r , \mathbf{v}'_r , and some vector ξ .

$$2\mathbf{v} = \mathbf{v}_r - \mathbf{v}'_r + \xi, \quad (3.28)$$

where ξ has length $2\sqrt{2}$ and is orthogonal to both \mathbf{v}_r and \mathbf{v}'_r . Let v' be a hollow vertex of $P_{2r} \cup \{v\}$ with Gram vector $\mathbf{v}' = \mathbf{v} - \xi$. The \mathbb{Z} -graph $P'_{2r} \cup \{v, v'\}$ is equal to the visibly cyclotomic \mathbb{Z} -graph $C_{2(r+1)}^{+-}$ and is therefore also cyclotomic. It remains to check that both v and v_r are $(P'_{2r} \cup \{v, v'\})$ -saturated in $P_{2r} \cup \{v\}$. First we treat the vertex v . Suppose that a vertex $x \in V(G) \setminus V(P_{2r} \cup \{v\})$ is adjacent to v .

Suppose that x is charged. The excluded subgraphs XC_1 and YC_2 rule out the possibility of $\langle \mathbf{x}, \mathbf{v} \rangle = 1 + i$, and so we assume $\langle \mathbf{x}, \mathbf{v} \rangle = 1$. Moreover, YC_1 forces x to have charge 1 and XC_{10} forces x to be adjacent to v_r . The exclusion of XC_4 , XC_5 , and YC_3 means that we must have $\langle \mathbf{x}, \mathbf{v}_r \rangle = -1$. Now, if x were adjacent to v_j for some $j \in \{1, \dots, r-1\}$ then, since such a vertex v_j is $(P'_{2r} \cup \{v, v'\})$ -saturated in $P_{2r} \cup \{v\}$, x would be switch-equivalent to some hollow vertex adjacent to v_j . Such hollow vertices are uncharged, hence, since

x is charged, its Gram vector \mathbf{x} must be orthogonal to \mathbf{v}_j for all $j \in \{1, \dots, r-1\}$. By Lemma 3.23, \mathbf{x} is also orthogonal to \mathbf{v}'_j for all $j \in \{1, \dots, r-1\}$. In particular, \mathbf{x} is orthogonal to \mathbf{v}_{r-1} , \mathbf{v}_{r-2} , and \mathbf{v}'_{r-2} . From taking the inner product of \mathbf{x} and equation (3.27) we have $\langle \mathbf{x}, \mathbf{v}'_r \rangle = -\langle \mathbf{x}, \mathbf{v}_r \rangle$. Hence $\langle \mathbf{x}, \mathbf{v}'_r \rangle = 1$, and the inner product of \mathbf{x} and equation (3.28) yields $\langle \mathbf{x}, \xi \rangle = 4$. Therefore we have $\mathbf{x} = -\mathbf{v}'$.

On the other hand, if x is uncharged, then the excluded subgraph YC_3 rules out the possibility of $\langle \mathbf{x}, \mathbf{v} \rangle = 1 + i$, and so we assume $\langle \mathbf{x}, \mathbf{v} \rangle = 1$. And the exclusion of the triangles having exactly one charge forces \mathbf{x} to be orthogonal to \mathbf{v}_r . Since XC_{11} has been excluded, x must be adjacent to the vertex v_{r-1} which is $(P'_{2r} \cup \{v, v'\})$ -saturated in $P_{2r} \cup \{v\}$, and hence \mathbf{x} must be switch-equivalent to \mathbf{v}'_r . Therefore, we have proved that v is $(P'_{2r} \cup \{v, v'\})$ -saturated in $P_{2r} \cup \{v\}$ and it remains to show that v_r is $(P'_{2r} \cup \{v, v'\})$ -saturated in $P_{2r} \cup \{v\}$.

Suppose that x is adjacent to v_r . Since we have excluded $YC_3, YC_4, YC_5, XC_{12}, XC_{13}, XC_{15}$, and XC_{16} , the vertex x must be adjacent to either of the vertices v_{r-1} or v . Both of these vertices are $(P'_{2r} \cup \{v, v'\})$ -saturated in $P_{2r} \cup \{v\}$ and hence x is switch-equivalent to some hollow vertex as required.

We have, then, that each vertex of $P_{2r} \cup \{v\}$ is $(P'_{2r} \cup \{v, v'\})$ -saturated in $P_{2r} \cup \{v\}$. Since $P'_{2r} \cup \{v, v'\}$ is $(P'_{2r} \cup \{v, v'\})$ -saturated in $P_{2r} \cup \{v\}$, the vertices of G correspond to vertices of $P'_{2r} \cup \{v, v'\}$. Two uncharged vertices cannot be switch-equivalent to the same vertex since YB_4 has been excluded as a subgraph. Suppose two charged vertices x and y are switch-equivalent to the same hollow vertex. They must have the same charge. If x and y have charge 1 then $|\langle \mathbf{x}, \mathbf{y} \rangle| = 3$ which violates Corollary 1.8. The vertices v_1 and v'_1 have charge -1 and both are switch-equivalent to the same vertex. But since we have excluded XC_6, XC_7 , and XC_8 , no three vertices of charge -1 can be switch-equivalent to the same vertex. The graph $P'_{2r} \cup \{v, v'\}$ is $C_{2(r+1)}^{+-}$ and hence, G is equivalent to a subgraph of $C_{2(r+1)}^{+-}$.

Case 2. Suppose that v has charge -1 . Argument is similar to Case 1, but this time $\xi = 0$. We deduce that G is contained in a $\mathbb{Z}[i]$ -graph equivalent to $C_{2(r+1)}^{++}$. ■

3.5.3 Charged \mathcal{L}_3 -free $\mathbb{Z}[i]$ -graphs on up to 5 vertices

We have exhaustively computed all charged \mathcal{L}_3 -free $\mathbb{Z}[i]$ -graphs on up to 5 vertices. Out of these graphs, the ones on 5 vertices contain a subgraph equivalent to P_6 (3 vertices). The growing process is similar to that described in Section 3.3.3, but in this case we can start

the process with a vertex having charge -1 . As before, this computation can be carried out by hand.

By the above computation and by iteratively applying Lemma 3.25 and Lemma 3.26 we have the following lemma.

Lemma 3.27. *Let G be a charged \mathcal{L}_3 -free $\mathbb{Z}[i]$ -graph. Then G is equivalent to a subgraph of one of the maximal cyclotomic $\mathbb{Z}[i]$ -graphs C_{2k}^{++} , C_{2k}^{+-} , or C_{2k-1} for some $k \geq 2$.*

Together with the computation of the maximal connected cyclotomic $\mathbb{Z}[i]$ -graphs containing the graphs from the list \mathcal{L}_3 (see Figure 3.14), we have proved Theorem 3.3.

3.6 The Eisenstein integers

The classification of cyclotomic matrices over $\mathbb{Z}[\omega]$ is very similar to the classification over $\mathbb{Z}[i]$. In this section we outline the differences that need to be considered for this classification.

3.6.1 Uncharged case

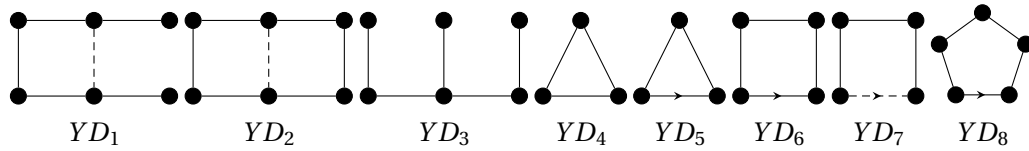

Figure 3.15: some cyclotomic $\mathbb{Z}[\omega]$ -graphs that are contained as subgraphs of fixed maximal connected cyclotomic $\mathbb{Z}[\omega]$ -graphs.

Excluded subgraph	Maximal cyclotomics
YD_1	$S_{12}, S_{14},$ and S_{16}
YD_2	$S_{12}, S_{14},$ and S_{16}
YD_3	$S_{12}, S_{14},$ and S_{16}
YD_4	$S_5, T_6,$ and S_7
YD_5	$T_6^{(\omega)}$
YD_6	$T_8^{(\omega)}$
YD_7	$T_8^{(\omega)}, S_{10},$ and S_{12}
YD_8	$T_{10}^{(\omega)}$

Table 3.6: Excluded subgraphs from Figure 3.15 and (up to equivalence) their containing maximal connected cyclotomic $\mathbb{Z}[\omega]$ -graphs.

The uncharged case follows Section 3.3. In Table 3.6 we list each excluded subgraph of type II in Figure 3.15 along with every maximal connected cyclotomic $\mathbb{Z}[\omega]$ -graph that contains it. Form a list of excluded subgraph consisting of charged vertices and the excluded subgraphs from Figures 3.9 and 3.15. Note that in Figure 3.15, the $\mathbb{Z}[\omega]$ -graph YD_4 is *not* equivalent to YD_5 whereas over $\mathbb{Z}[i]$ these two graphs are equivalent. We effectively have the same list of excluded subgraphs as we had working over $\mathbb{Z}[i]$. The key requisites of the lemmata of Section 3.3 are the set of excluded subgraphs and that the action of the group of units of $\mathbb{Z}[\omega]$ acts transitively on the set $S \setminus \{0\}$. Let S be the set containing 0 and the units of $\mathbb{Z}[\omega]$, namely, $S = \{0, \pm 1, \pm \omega, \pm \bar{\omega}\}$. Then by following Section 3.3 with this new set S and our list of excluded subgraphs, we obtain a proof of the classification of cyclotomic S -graphs.

The only elements of $\mathbb{Z}[\omega]$ of norm greater than 1 and at most 4 are the associates of $1 + \omega$ or 2. A simple computation confirms that any cyclotomic graph containing a subgraph equivalent to a weight- $(1 + \omega)$ edge or a weight-2 edge must itself be equivalent to a subgraph of S_4^\dagger or S_2 respectively. Corollary 1.8 takes care of the remainder of the elements of $\mathbb{Z}[\omega]$ and we have completed the proof of Theorem 3.5.

3.6.2 Charged case

In Table 3.7 we list each excluded subgraph of type II in Figure 3.17 along with every maximal connected cyclotomic $\mathbb{Z}[\omega]$ -graph that contains it. Form a list of excluded subgraphs consisting of the excluded subgraphs from Figures 3.9, 3.15, 3.16, and 3.17. Again, there exist charged excluded subgraphs that are not equivalent over $\mathbb{Z}[\omega]$ but are equivalent over $\mathbb{Z}[i]$. As in the uncharged case, we have the requisites for the lemmata of Section 3.5; using excluded subgraphs and Corollary 1.8 we can rule out matrices that have an entry of norm greater than 1. We have effectively the same list of excluded subgraphs and, in fact, the argument is simpler in this case, since there are no elements in $\mathbb{Z}[\omega]$ having norm 2, whereas over $\mathbb{Z}[i]$ we had to consider edge-weights of norm 2.

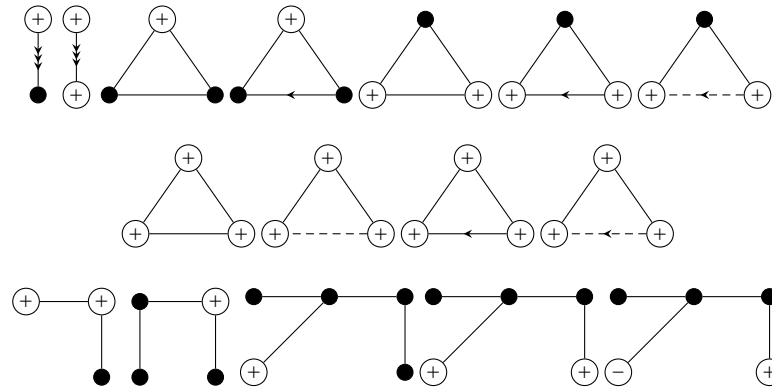

Figure 3.16: some non-cyclotomic charged $\mathbb{Z}[\omega]$ -graphs.

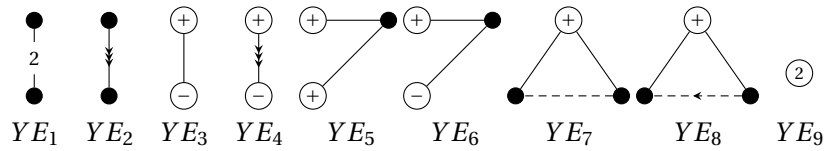

Figure 3.17: some charged cyclotomic $\mathbb{Z}[\omega]$ -graphs that are contained as subgraphs of fixed maximal connected cyclotomic $\mathbb{Z}[\omega]$ -graphs.

Excluded subgraph	Maximal cyclotomics
YE_1	S_2
YE_2	S_4^\ddagger
YE_3	$C_4^{+-}, S_6, S_6^\dagger, S_7, S_8,$ and S_8'
YE_4	S_2^\dagger
YE_5	$S_5, C_6^{++},$ and S_7
YE_6	C_6^{+-} and S_8'
YE_7	$S_6^\dagger, S_7,$ and S_8'
YE_8	S_5
YE_9	S_1

Table 3.7: Excluded subgraphs from Figure 3.17 and (up to equivalence) their containing maximal connected cyclotomic $\mathbb{Z}[\omega]$ -graphs.

3.7 Lehmer's problem

The motivation for this section is Lehmer's problem. We would like to find a bound $\varepsilon > 0$ such that, if $M(R_A) > 1$ then $M(R_A) \geq 1 + \varepsilon$ where A is a Hermitian matrix over the Eisenstein integers or the Gaussian integers. Our main result is the reduction of this problem to a finite search.

3.7.1 Preliminaries

We use \odot to represent a vertex having any charge; all vertices are equivalent to \odot . The edge labelling $- * -$ represents an edge having any weight; all edges are equivalent to the edge $- * -$. We record for later use the following obvious facts that follow immediately from the classification of cyclotomic matrices over $\mathbb{Z}[i]$ and $\mathbb{Z}[\omega]$.

Corollary 3.28. *Any connected cyclotomic $\mathbb{Z}[i]$ -graph that is equivalent to a subgraph of $T_{2k}, T_{2k}^{(i)}, C_{2k}, C_{2k+1}, C_{2k}^{++},$ or C_{2k}^{+-} is strongly equivalent to a subgraph of $T_{2k}, T_{2k}^{(i)}, C_{2k}, \pm C_{2k+1}, \pm C_{2k}^{++},$ or C_{2k}^{+-} .*

Corollary 3.29. *Any connected cyclotomic $\mathbb{Z}[\omega]$ -graph that is equivalent to a subgraph of $T_{2k}, T_{2k}^{(\omega)}, C_{2k}^{++},$ or C_{2k}^{+-} is strongly equivalent to a subgraph of $T_{2k}, T_{2k}^{(\omega)}, \pm C_{2k}^{++},$ or C_{2k}^{+-} .*

There are two types of maximal cyclotomic graphs.

The **sporadics**: $S_1, S_2, S_2^\dagger, S_4, S_4^\dagger, S_4^\ddagger, S_5, S_6, S_6^\dagger, S_7, S_8, S_8', S_8^\dagger, S_8^\ddagger, S_8^\ddagger, S_{10}, S_{12}, S_{14},$ and S_{16} ; see Figures 3.5, 3.6, 3.7, and 3.8.

The **non-sporadics**: $T_{2k}(k \geq 3), T_{2k}^{(i)}(k \geq 3), T_{2k}^{(\omega)}(k \geq 3), C_{2k}(k \geq 2), C_{2k}^{++}(k \geq 2), C_{2k}^{+-}(k \geq 2),$ and $C_{2k+1}(k \geq 1)$; see Figures 3.1, 3.2, 3.3, and 3.4.

A graph is called **minimal non-cyclotomic** if it has at least one eigenvalue lying outside of the interval $[-2, 2]$ and is minimal in that respect, i.e., none of its subgraphs is non-cyclotomic. A graph is called **non-supersporadic** if all of its proper connected subgraphs are equivalent to subgraphs of non-sporadics and **supersporadic** otherwise.

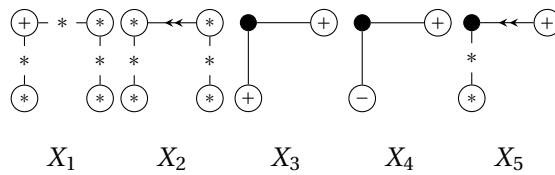

Figure 3.18: Some $\mathbb{Z}[i]$ -graphs that are not subgraphs of any non-supersporadic graph having at least 5 vertices.

Given a graph G , a path (respectively cycle) P is called **chordless** if the subgraph of G induced on the vertices of P is a path (respectively cycle). Define the **path rank** of G to be the maximal number of vertices in a chordless path or cycle of G . Following McKee and Smyth [26], we say that G has a **profile** if its vertices can be partitioned into a sequence of $k \geq 3$ subsets C_0, \dots, C_{k-1} such that either

- two vertices v and w are adjacent if and only if $v \in \mathcal{C}_{j-1}$ and $w \in \mathcal{C}_j$ for some $j \in \{1, \dots, k-1\}$ or v and w are both charged vertices in the same subset

or

- two vertices v and w are adjacent if and only if $v \in \mathcal{C}_{j-1}$ and $w \in \mathcal{C}_j$ for some $j \in \mathbb{Z}/k\mathbb{Z}$ or v and w are both charged vertices in the same subset.

In the latter case, we say that the profile is **cycl**ing. Given a graph G with a profile $\mathcal{C} = (\mathcal{C}_0, \dots, \mathcal{C}_{k-1})$ we define the **profile rank** of G to be k , the number of subsets in the profile \mathcal{C} .

Later we will also need the following corollaries.

Corollary 3.30. *Let G be a connected charged non-supersporadic graph. Then the longest chordless cycle has length 4.*

Proof. Suppose G contains a chordless cycle C on at least 5 vertices.

Case 1. C is uncharged. Since G is charged, a charged vertex must be joined to the cycle via some path. Let v be the intersection of the vertices of this path and the cycle. By deleting a vertex of the cycle that is not a neighbour of v (and not v), we obtain a non-cyclotomic subgraph of G , which is impossible.

Case 2. C is charged. Since G is non-supersporadic, each of its edge-weights and charges has norm at most 2. It is not possible to construct a charged chordless sub-cycle on more than 4 vertices without X_1 of Figure 3.18 being a subgraph. Hence we are done. ■

The next corollary follows with a proof similar to that of Corollary 3.30.

Corollary 3.31. *Let G be a connected non-supersporadic graph that has at least one edge-weight of norm 2. Then the longest chordless cycle has length 4.*

Corollary 3.32. *Let G be a connected charged non-supersporadic graph having path rank $r \geq 5$. If G has a profile \mathcal{C} then \mathcal{C} is not cycling and the charged vertices must be contained in columns at either end of \mathcal{C} .*

Proof. By Corollary 3.30, the profile \mathcal{C} of G cannot be cycling. The subgraph X_1 of Figure 3.18 which cannot be equivalent to a subgraph of G forces the charges of G to be in the first or last column of \mathcal{C} . ■

Again, the next corollary has essentially the same proof.

Corollary 3.33. *Let G be a connected non-supersporadic graph that has at least one edge-weight of norm 2 and has path rank $r \geq 5$. If G has a profile C then C is not cycling and the edges of norm 2 must be between vertices of the first two or the last two columns of C .*

In order to classify all minimal non-cyclotomic graphs we must consider all possible ways of attaching a single vertex to every cyclotomic graph. As it stands, we need to test an infinite number of graphs, but we will reduce the amount of work required, so that it suffices to test all the supersporadic graphs (of which there are only finitely many) and the non-supersporadic graphs on up to 10 vertices.

3.7.2 Reduction to a finite search

In this section we reduce the search for minimal non-cyclotomic matrices to a finite one. Proposition 3.36 below, enables us to restrict our search for minimal non-cyclotomic graphs to a search of all non-supersporadic graphs on up to 10 vertices and all minimal non-cyclotomic supersporadic graphs.

Lemma 3.34. *Let G be equivalent to a connected subgraph of a non-sporadic graph. If G has path rank at least 5 then this equals its profile rank, and its columns are uniquely determined. Moreover, their order is determined up to reversal or cycling.*

Proof. Follows from the proof of [26, Lemma 6]. ■

Lemma 3.35. *Let G be an n -vertex proper connected subgraph of a non-sporadic graph where $n \geq 8$. Then its path rank equals its profile rank and its columns are uniquely determined. Moreover, their order is determined up to reversal or cycling.*

Proof. If G has path rank at least 5 then we can apply Lemma 3.34. Since having at least 9 vertices forces G to have path rank at least 5, we can assume that $n = 8$ and that G has path rank 4. Let P be a chordless path or cycle with maximal number of vertices r . If the maximal cycle length is equal to the maximal path length, then take P to be a path. Now, every proper connected 8-vertex subgraph of a non-sporadic graph contains a chordless path on 4 vertices. Therefore, P must be a path. The columns of the profile of P inherited from that of G are singletons. Because the profile is not cycling, the column to which a new vertex can be added is completely determined by the vertices it is adjacent to in G . ■

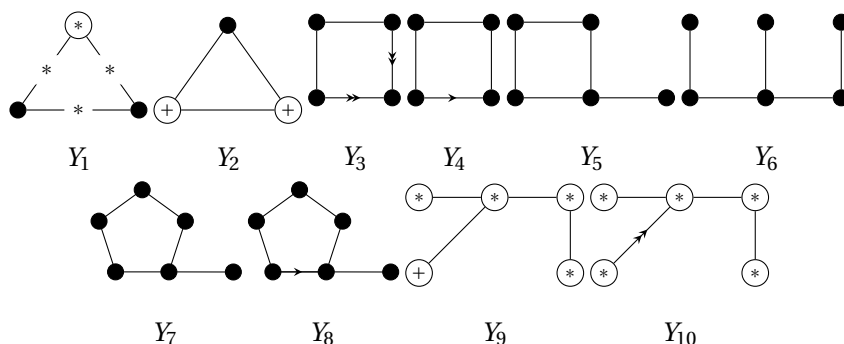

Figure 3.19: Some $\mathbb{Z}[i]$ -graphs that are *not* subgraphs of any non-supersporadic graph on at least 10 vertices.

The graphs in Figure 3.19 are *not* subgraphs of any non-supersporadic graph on at least 10 vertices. In the following proposition we shall treat only the ring $\mathbb{Z}[i]$ since the arguments are the same, if not slightly simpler, for $\mathbb{Z}[\omega]$.

Proposition 3.36. *Let G be a connected non-supersporadic $\mathbb{Z}[i]$ -graph with $n \geq 10$ vertices. Then G is equivalent to a subgraph of a non-sporadic $\mathbb{Z}[i]$ -graph.*

Proof. Let G satisfy the assumption of the proposition. Take a chordless path or cycle P of G with maximal number of vertices. Let x and y be the endvertices of P if P is a path, otherwise if P is a cycle, let x and y be any two adjacent vertices of P . If there simultaneously exist chordless paths and chordless cycles in G both containing the maximal number of vertices then we take P to be one of the paths.

Claim 1. *The subgraphs $G \setminus \{x\}$, $G \setminus \{y\}$, and $G \setminus \{x, y\}$ are connected.*

If a vertex x' of G is adjacent to x , then it must also be adjacent to another vertex of P otherwise, if P is a path, there exists a longer chordless path or, if P is a cycle, there exists a chordless path with the same number of vertices of P . It follows that $G \setminus \{x\}$ is connected. This is similar for $G \setminus \{y\}$.

Now suppose P is a chordless cycle and there exists some vertex z not on P that is adjacent to both x and y and to no other vertex of P . Since the graph Y_1 cannot be equivalent to any subgraph of G , the triangle xyz must have at least two charges, and hence at least one of x or y is charged. Therefore P is a charged chordless cycle of length at least 5. But, by Corollary 3.30, the longest charged chordless cycle of G has length 4, which gives a contradiction. Therefore, $G \setminus \{x, y\}$ is connected and we have proved Claim 1.

Next we show that G has a profile.

Claim 2. G has a profile.

Since G is non-sporadic, the connected subgraphs $G \setminus \{x\}$ and $G \setminus \{y\}$ are cyclotomic. Moreover, since they have at least 9 vertices, they must have path rank at least 5, and hence, by Lemma 3.34, they have uniquely determined profiles. The connected subgraph $G \setminus \{x, y\}$ has at least 8 vertices and is a proper subgraph of the cyclotomic graph $G \setminus \{x\}$. Thus, by Lemma 3.35, $G \setminus \{x, y\}$ has a uniquely determined profile.

By Corollary 3.28, we can switch $G \setminus \{x\}$ to obtain a subgraph G_x of one of T_{2k} , $T_{2k}^{(i)}$, C_{2k} , $\pm C_{2k+1}$, $\pm C_{2k}^{++}$, and C_{2k}^{+-} for some k . We can simultaneously switch $G \setminus \{y\}$ to obtain a subgraph G_y so that $G_x \setminus \{y\}$ and $G_y \setminus \{x\}$ are the same subgraph which we will call G_{xy} .

Let \mathcal{C}' be the profile of G_{xy} . Since it is uniquely determined, the profile of G_x (respectively G_y) can be obtained by the addition of x (respectively y) to the profile \mathcal{C}' of G_{xy} . In particular, to obtain the profile of G_x (respectively G_y), either the vertex x (respectively y) is given its own column at one end of \mathcal{C}' or it is added to the first or last column of \mathcal{C}' . Now merge the profiles of G_x and G_y to give a sequence of columns \mathcal{C} . We will show that \mathcal{C} is a profile for G .

Let $q \geq 5$ be the number of columns of \mathcal{C} and denote by \mathcal{C}_j the j th column of \mathcal{C} , where \mathcal{C}_{q-1} is the column containing x and \mathcal{C}_0 is the column containing y . Suppose that no vertex of column \mathcal{C}_0 is adjacent to any vertex of column \mathcal{C}_{q-1} . Since no subgraph of G can be equivalent to $X_1, X_2, X_3, X_4, X_5, Y_2, Y_3, Y_9$, or Y_{10} , we have that G is equivalent to a subgraph of a non-sporadic graph, and moreover \mathcal{C} is a profile for G .

Otherwise, suppose that some vertex u of \mathcal{C}_{q-1} is adjacent to some vertex v of \mathcal{C}_0 with $w(u, v) = s$ for some $s \in \mathbb{Z}[i]$. By Corollary 3.30, since G has a chordless cycle of length at least 5 it must be uncharged and moreover, by Corollary 3.31 each edge-weight of G must be in the group of units of $\mathbb{Z}[i]$. Furthermore, any other vertex in \mathcal{C}_{q-1} must be adjacent to some vertex in \mathcal{C}_0 otherwise it would contain a subgraph equivalent to Y_6, Y_7 , or Y_8 , which is impossible. Hence \mathcal{C} is a profile for G as required for Claim 2.

It remains to demonstrate that, when \mathcal{C} is cycling, G is equivalent to a non-sporadic graph. In particular, we will show that G is equivalent to a subgraph of T_{2k} , $T_{2k}^{(i)}$, or C_{2k} . By above, we have that G is uncharged and, since no subgraph of G can be equivalent to Y_1 , we have that G is triangle-free. And for $j \in \{1, \dots, q-1\}$ we have, for any vertex a in \mathcal{C}_j and vertices b and b' in \mathcal{C}_{j+1} , the equality $w(a, b) = w(a, b')$, and for any vertex b in \mathcal{C}_{j+1} and vertices a and a' in \mathcal{C}_j , the equality $w(a, b) = -w(a', b)$. Each of these edge-weights is ± 1 .

Suppose there exists another vertex u' in \mathcal{C}_{q-1} that is adjacent to v . Let z be a vertex in

the column \mathcal{C}_{q-2} , which has $w(z, u) = w(z, u')$. Thus, in order for G to avoid containing a subgraph equivalent to either Y_4 or Y_5 , we must have that $w(u', v) = -s$. Similarly, if there exists another vertex v' in \mathcal{C}_0 which is adjacent to u , then $w(u, v') = s$. And hence, if there exist vertices u' and v' different from u and v with u' in \mathcal{C}_{q-1} and v' in \mathcal{C}_0 , then $w(u', v) = -s$ and $w(u, v') = s$. Since z in the column \mathcal{C}_{q-2} has $w(z, u) = w(z, u')$, in order for G to avoid containing a subgraph equivalent to either Y_4 or Y_5 , we must have that $w(u', v') = -s$. Therefore, G is equivalent to a subgraph of T_{2k} , $T_{2k}^{(i)}$, or C_{2k} for some k . ■

Hermitian Matrices over Real Quadratic Integer Rings

In this chapter, for $d > 0$, we classify cyclotomic $\mathcal{O}_{\mathbb{Q}(\sqrt{d})}$ -matrices and we confirm Lehmer's conjecture for the polynomials R_A , where A is a Hermitian $\mathcal{O}_{\mathbb{Q}(\sqrt{d})}$ -matrix. Let \mathcal{R} be the compositum of all real quadratic integer rings $\mathcal{O}_{\mathbb{Q}(\sqrt{d})}$ where $d > 1$ is squarefree. Given a symmetric \mathcal{R} -matrix A , let L_A denote the smallest normal extension of \mathbb{Q} that contains all the entries of A . We define \mathfrak{S}'_n to be the set of $n \times n$ symmetric \mathcal{R} -matrices A such that the spectrum of $\sigma(A)$ is contained in $[-2, 2]$ for all $\sigma \in \text{Gal}(L_A/\mathbb{Q})$. We also define a finer set \mathfrak{S}_n as the set of matrices from \mathfrak{S}'_n having integral characteristic polynomials. Notice that \mathfrak{S}_n is precisely the set of $n \times n$ cyclotomic \mathcal{R} -matrices. We show that for $n > 6$, the two sets \mathfrak{S}_n and \mathfrak{S}'_n are equal.

4.1 Integral characteristic polynomials

As we saw in the previous chapter, if A is a Hermitian matrix over an imaginary quadratic integer ring then its characteristic polynomial has integer coefficients. Hence, if A also has all of its eigenvalues in the interval $[-2, 2]$, then A is cyclotomic. However, over real quadratic integer rings, things are not so simple. For example, the matrix

$$\begin{pmatrix} \sqrt{2} & 1 \\ 1 & 0 \end{pmatrix}$$

has all its eigenvalues lying in the interval $[-2, 2]$ but its characteristic polynomial does not have integral coefficients, hence it is not cyclotomic. It is clear from the above example that \mathfrak{S}'_2 *strictly* contains \mathfrak{S}_2 . This complication of having to worry about whether or not the characteristic polynomial is integral is the reason we treat real quadratic integer rings separately to the imaginary quadratic integer rings.

There is, though, a redeeming feature of working over subrings of the real numbers; here we have a notion of nonnegativity and we can therefore make use of Perron-Frobenius

theory. It is possible to ensure the integrality of a matrix by giving its associated graph a certain symmetry. Let K be a normal extension of \mathbb{Q} with R its ring of integers. We say that a Hermitian R -matrix A is **Galois invariant** if it is strongly equivalent to itself under Galois conjugation, i.e., for all $\sigma \in \text{Gal}(K/\mathbb{Q})$, A is strongly equivalent to $\sigma(A)$.

Proposition 4.1. *Let A be a Galois-invariant symmetric R -matrix. Then its characteristic polynomial χ_A has integer coefficients.*

Proof. For all $\sigma \in \text{Gal}(K/\mathbb{Q})$, applying σ to the coefficients of χ_A gives

$$\sigma(\chi_A(x)) = \det(xI - \sigma(A)) = \det(xI - A) = \chi_A(x).$$

Hence, the characteristic polynomial χ_A must have rational coefficients. And since the entries of A are algebraic integers, so too are the coefficients of χ_A . ■

We observed earlier that all Hermitian matrices over imaginary quadratic integer rings are Galois invariant. It can be readily seen below, in the classification of cyclotomic \mathcal{R} -matrices, that the converse of the proposition does not hold. For example, the maximal cyclotomic \mathcal{R} -graph $S_4^{(2,\varphi)}$ of Figure 4.7 is not Galois invariant, in fact, it is the only such example; all other maximal cyclotomic \mathcal{R} -graphs are Galois invariant.

4.2 Classification of cyclotomic \mathcal{R} -matrices

Before stating our results, we outline our graph drawing conventions. We draw edges with edge-weight w as $\overset{w}{\text{---}}$ and edges of weight $-w$ as $\overset{-w}{\text{---}}$. When it is clear which weights correspond to each edge we draw edges of weight w and $-w$ as $\overset{w}{\text{---}}$ and $\overset{-w}{\text{---}}$ respectively. If $w = 1$, we simply draw a solid line --- and a dashed line - - - - respectively. A vertex with charge c for some $c > 0$ is drawn as $\text{\textcircled{c}}$ and a vertex with charge $-c$ is drawn as $\text{\textcircled{-c}}$. And if a vertex is uncharged, we simply draw \bullet . An uncharged hollow vertex is drawn as \circ . By a **subgraph** H of G we mean an induced subgraph: a subgraph obtained by deleting vertices and their incident edges. We say that G **contains** H and that G is a **supergraph** of H . A graph is called **charged** if it contains at least one charged vertex, otherwise it is called **uncharged**.

Theorem 4.2. [25] *Let A be a maximal indecomposable cyclotomic \mathbb{Z} -matrix. Then A is equivalent to an adjacency matrix of one of the graphs T_{2k} (for $k > 2$), C_{2k}^{++} (for $k > 1$), C_{2k}^{+-} (for $k > 1$), $S_1, S_2, S_7, S_8, S'_8, S_{14}$, and S_{16} in Figures 4.1, 4.3, 4.5, 4.6, 4.7, and 4.8.*

Moreover, every indecomposable cyclotomic \mathbb{Z} -matrix is contained in a maximal one.

4. Hermitian Matrices over Real Quadratic Integer Rings

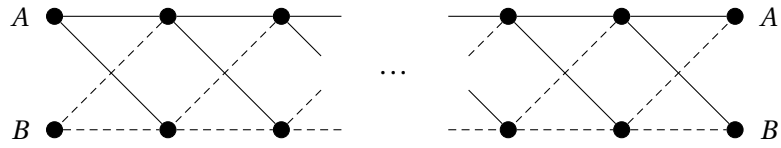

Figure 4.1: The family T_{2k} of $2k$ -vertex maximal connected cyclotomic \mathbb{Z} -graphs, for $k \geq 3$. (The two copies of vertices A and B should be identified to give a toral tessellation.)

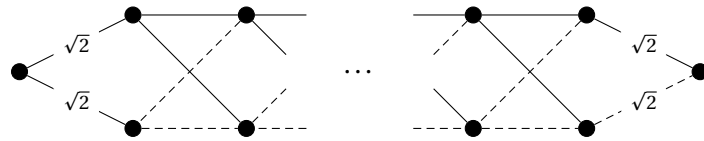

Figure 4.2: The family of $2k$ -vertex maximal connected cyclotomic $\mathbb{Z}[\sqrt{2}]$ -graphs C_{2k} for $k \geq 2$.

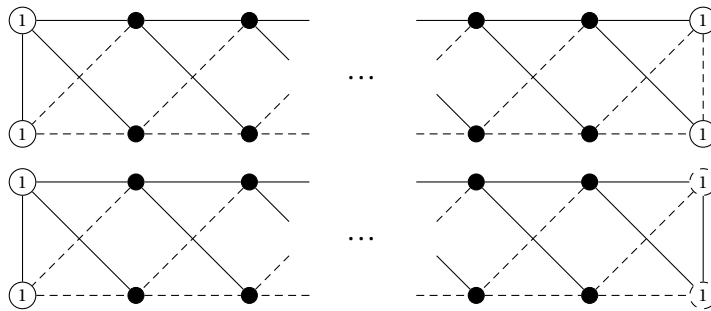

Figure 4.3: The families of $2k$ -vertex maximal connected cyclotomic \mathbb{Z} -graphs C_{2k}^{++} and C_{2k}^{+-} for $k \geq 2$.

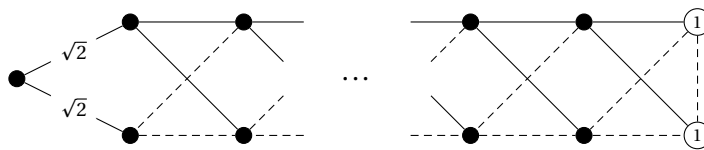

Figure 4.4: The family of $(2k + 1)$ -vertex maximal connected cyclotomic $\mathbb{Z}[\sqrt{2}]$ -graphs C_{2k+1} for $k \geq 1$.

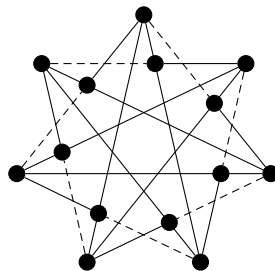

Figure 4.5: The sporadic maximal connected cyclotomic \mathbb{Z} -graph S_{14} of order 14.

4. Hermitian Matrices over Real Quadratic Integer Rings

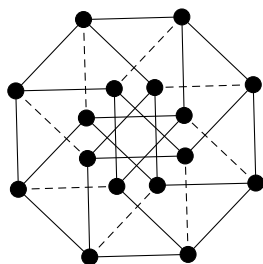

Figure 4.6: The sporadic maximal connected cyclotomic \mathbb{Z} -hypercube S_{16} .

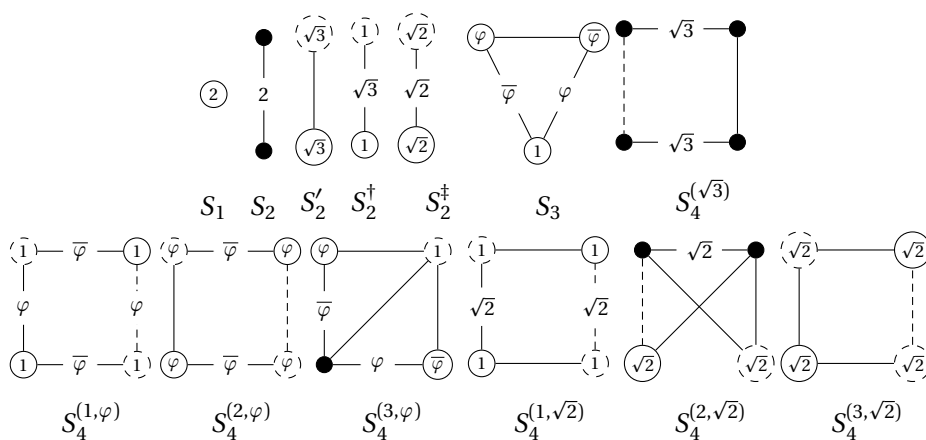

Figure 4.7: The sporadic maximal connected cyclotomic \mathcal{R} -graphs of orders 1, 2, 3 and 4.

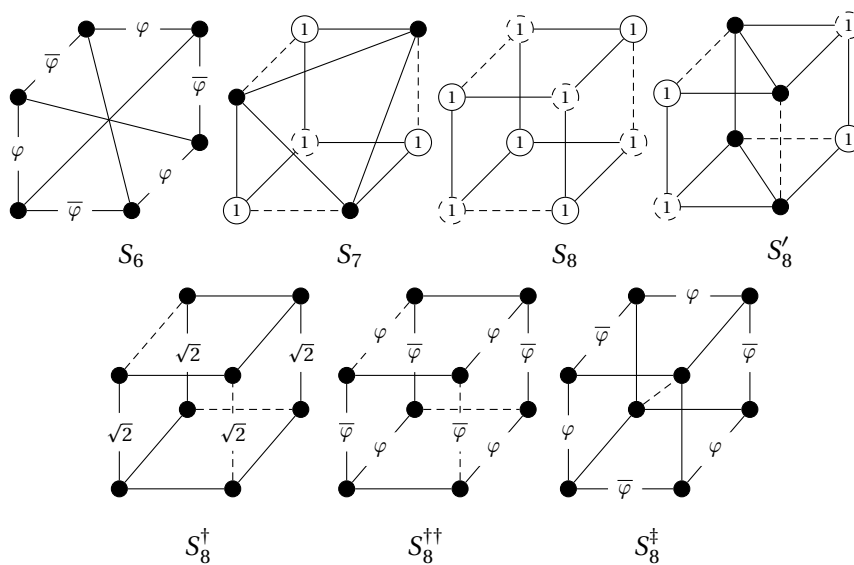

Figure 4.8: The sporadic maximal connected cyclotomic \mathcal{R} -graphs of orders 6, 7, and 8.

Theorem 4.3. *Let A be a maximal indecomposable cyclotomic matrix over the ring $\mathbb{Z}[\sqrt{2}]$ that is not a \mathbb{Z} -matrix. Then A is equivalent to an adjacency matrix of one of the graphs C_{2k} (for $k > 1$), C_{2k+1} (for $k > 0$), S_2^\dagger , $S_4^{(1,\sqrt{2})}$, $S_4^{(2,\sqrt{2})}$, $S_4^{(3,\sqrt{2})}$, and S_8^\dagger in Figures 4.2, 4.4, 4.7, and 4.8.*

Moreover, every indecomposable cyclotomic $\mathbb{Z}[\sqrt{2}]$ -matrix is contained in a maximal one.

Let φ denote the golden ratio, $1/2 + \sqrt{5}/2$, so that $\mathbb{Z}[\varphi]$ is the ring of integers of $\mathbb{Q}(\sqrt{5})$.

Theorem 4.4. *Let A be a maximal indecomposable cyclotomic matrix over the ring $\mathbb{Z}[\varphi]$ that is not a \mathbb{Z} -matrix. Then A is equivalent to an adjacency matrix of one of the graphs S_3 , $S_4^{(1,\varphi)}$, $S_4^{(2,\varphi)}$, $S_4^{(3,\varphi)}$, S_6 , $S_8^{\dagger\dagger}$, and S_8^\dagger in Figures 4.7 and 4.8.*

Moreover, every indecomposable cyclotomic $\mathbb{Z}[\varphi]$ -matrix is contained in a maximal one.

Theorem 4.5. *Let A be a maximal indecomposable cyclotomic matrix over the ring $\mathbb{Z}[\sqrt{3}]$ that is not a \mathbb{Z} -matrix. Then A is equivalent to an adjacency matrix of one of the graphs S_2' , S_4^\dagger , and $S_4^{(\sqrt{3})}$ in Figure 4.7.*

Moreover, every indecomposable cyclotomic $\mathbb{Z}[\sqrt{3}]$ -matrix is contained in a maximal one.

Theorem 4.4 can be proved by computation of $\mathbb{Z}[\varphi]$ -matrices up to degree 8 and for Theorem 4.5 it suffices to compute $\mathbb{Z}[\sqrt{3}]$ -matrices up to degree 4. By interlacing, for all $k \geq 2$, each matrix in \mathfrak{S}'_k contains at least one matrix from \mathfrak{S}'_{k-1} . From our computations, we have that there are no $\mathbb{Z}[\varphi]$ -matrices in \mathfrak{S}'_9 , and hence, by interlacing, neither are there $\mathbb{Z}[\varphi]$ -matrices in \mathfrak{S}'_k for $k > 9$ and similarly, there are no $\mathbb{Z}[\sqrt{3}]$ -matrices in \mathfrak{S}'_k for $k > 4$. Theorem 4.3 follows from the technique which we used in the previous chapter. We will give the proof in Section 4.3.

Let \mathcal{R} be the compositum of all real quadratic integer rings $\mathcal{O}_{\mathbb{Q}(\sqrt{d})}$ where $d > 1$ is squarefree.

Theorem 4.6. *Let A be an indecomposable cyclotomic matrix over the ring \mathcal{R} . Then A is a symmetric matrix over \mathbb{Z} , $\mathbb{Z}[\sqrt{2}]$, $\mathbb{Z}[\varphi]$, or $\mathbb{Z}[\sqrt{3}]$.*

Corollary 4.7. *For $n > 6$ we have $\mathfrak{S}_n = \mathfrak{S}'_n$.*

In Section 4.4, after stating the Perron-Frobenius theorem, we prove Theorem 4.6 and Corollary 4.7.

4.3 Proof of Theorem 4.3

In this section we prove Theorem 4.3. The proof of Theorem 4.3 resembles the proofs of Theorem 3.2 and Theorem 3.3 in Section 3.4 and Section 3.5 and we use the ideas from Section 3.2. Let G be a cyclotomic $\mathbb{Z}[\sqrt{2}]$ -graph. By Corollary 1.8, we know that the adjacency matrix of G cannot be equivalent to a matrix containing an entry α where the norm of α is greater than 4. Therefore G can have edge-weights and charges coming only from the subset

$$\{0, \pm 1, \pm\sqrt{2}, \pm 2\}.$$

Since all of the weights are real, we can assume that the Gram vectors of the vertices of G are all contained in some Euclidean space. We use the dot product of these vectors for the adjacency of their corresponding vertices.

4.3.1 Excluded subgraphs

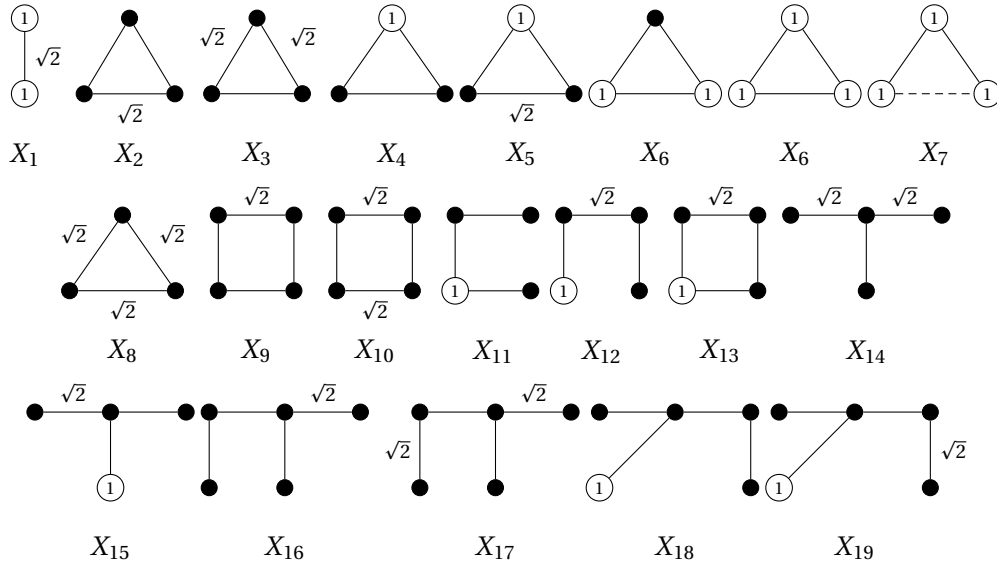

Figure 4.9: some non-cyclotomic $\mathbb{Z}[\sqrt{2}]$ -graphs.

In Table 4.1 we list each excluded subgraph of type II in Figure 4.10 along with every maximal connected cyclotomic $\mathbb{Z}[\sqrt{2}]$ -graph that contains it. Let \mathcal{L}_4 consist of the graphs in Figure 4.10. We weaken slightly the definition of an \mathcal{L}_4 -free graph so that such a graph need not be cyclotomic, instead it need only have all its eigenvalues contained inside the interval $[-2, 2]$. Since we have excluded $X_2, X_3, X_8,$ and X_9 , no \mathcal{L}_4 -free $\mathbb{Z}[\sqrt{2}]$ -graph can contain, as a subgraph, an uncharged triangle. We refer to this fact as the ‘exclusion of

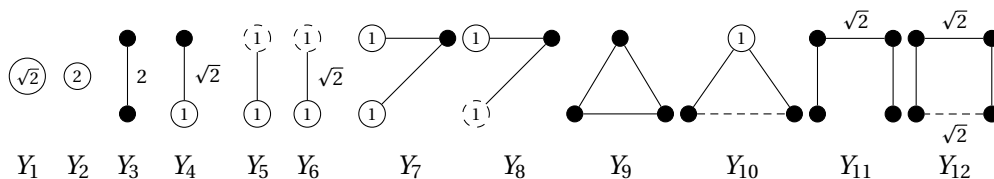

Figure 4.10: some cyclotomic $\mathbb{Z}[\sqrt{2}]$ -graphs that are contained as subgraphs of fixed maximal connected cyclotomic $\mathbb{Z}[\sqrt{2}]$ -graphs.

Excluded subgraph	Maximal cyclotomics
Y_1	$S_2^\dagger, S_4^{(2,\sqrt{2})}$, and $S_4^{(3,\sqrt{2})}$
Y_2	S_1
Y_3	S_2
Y_4	C_3
Y_5	S_7, S_8 , and S'_8
Y_6	$S_4^{(1,\sqrt{2})}$
Y_7	C_6^{++} and S_7
Y_8	C_6^{+-} and S'_8
Y_9	T_6 and S_7
Y_{10}	S_7 and S'_8
Y_{11}	S_8^\dagger
Y_{12}	S_8^\dagger

Table 4.1: Excluded subgraphs from Figure 4.10 and (up to equivalence) their containing maximal connected cyclotomic $\mathbb{Z}[\sqrt{2}]$ -graphs.

uncharged triangles'. We also refer to the exclusion of triangles containing exactly one charged vertex.

4.3.2 Inductive lemmata

Define P_{2r+1} (solid vertices) and P'_{2r+1} (solid vertices and hollow vertices) with the following $\mathbb{Z}[\sqrt{2}]$ -graph

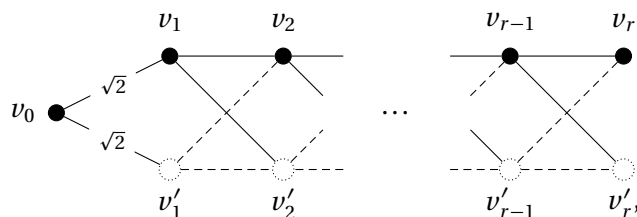

where $r \geq 1$. We have already named graphs P_{2r+1} and P'_{2r+1} in the previous chapter, but we use the same name again here hoping this does not result in confusion. In fact, the

graphs P_{2r+1} and P'_{2r+1} in the previous chapter are strongly equivalent over $\mathbb{Q}(i, \sqrt{2})$ to their counterparts in this chapter. As before, the set of hollow vertices of P_{2r+1} is the set $V(P'_{2r+1}) \setminus V(P_{2r+1})$. Clearly both P_{2r+1} and P'_{2r+1} are cyclotomic since they are contained in $C_{2(r+1)}$. Note that P_{2r+1} has $r+1$ vertices and P'_{2r+1} has $2r+1$ vertices. Having chosen Gram vectors $\mathbf{v}_0, \dots, \mathbf{v}_r$, we can write

$$\mathbf{v}'_1 = -\mathbf{v}_1 + \sqrt{2}\mathbf{v}_0 \quad (4.1)$$

and

$$\mathbf{v}'_2 = -\mathbf{v}_2 + 2\mathbf{v}_1 - \sqrt{2}\mathbf{v}_0. \quad (4.2)$$

Lemma 4.8. *In P_{2r+1} for $r \geq 2$, we can write the Gram vector for each hollow vertex in terms of Gram vectors of the vertices as follows:*

$$\mathbf{v}'_t = -\mathbf{v}_t - 2 \sum_{j=1}^{t-1} (-1)^{t+j} \mathbf{v}_j - (-1)^t \sqrt{2}\mathbf{v}_0, \quad \text{for } t \in \{1, \dots, r\}.$$

Proof. By induction using equations (4.1), (4.2), and Lemma 3.8. Similar to the proof of Lemma 3.18. ■

Lemma 4.9. *Let G be an \mathcal{L}_4 -free $\mathbb{Z}[\sqrt{2}]$ -graph containing P_{2r+1} with $r \geq 2$. Then, for each vertex $v \in V'_4(P_{2r+1})$, we have that $N_G(v) = N'_G(v)$. Hence, each vertex in $V'_4(P_{2r+1})$ is P'_{2r+1} -saturated in P_{2r+1} .*

Proof. Fix Gram vectors for P'_{2r+1} . We want to show that, for all vertices $v \in V'_4(P_{2r+1})$, we have $N_G(v) = N'_G(v)$. Since P'_{2r+1} contains P_{2r+1} , we have $N_G(v) \cap V(P_{2r+1}) = N'_G(v) \cap V(P_{2r+1})$ for all vertices $v \in V(G)$. Let v be a vertex in $V(G) \setminus V(P_{2r+1})$. Suppose that v is adjacent to the vertex $v_j \in V'_4(P_{2r+1})$ for some $j \in \{0, \dots, r-1\}$. Without loss of generality, either $\mathbf{v} \cdot \mathbf{v}_j = 1$ or $\mathbf{v} \cdot \mathbf{v}_j = \sqrt{2}$.

For our basic case, suppose first that $j = 0$. We begin by showing that v must be uncharged. Suppose for a contradiction that v is charged. We have $\mathbf{v} \cdot \mathbf{v}_0 = 1$ since we have excluded Y_4 . The exclusion of triangles containing a single charged vertex implies that $\mathbf{v} \cdot \mathbf{v}_1 = 0$, and X_{12} forces v to be adjacent to v_2 . But then G contains a subgraph equivalent to either Y_4 or X_{13} , which is impossible. Hence v must be uncharged. The exclusion of uncharged triangles implies that $\mathbf{v} \cdot \mathbf{v}_1 = 0$. Since we have excluded X_9 , X_{10} , Y_{11} , and Y_{12} , we must have $\mathbf{v} \cdot \mathbf{v}_0 = \sqrt{2}$. Taking the dot product of \mathbf{v} and equation (4.1), yields the equality $\mathbf{v} = \mathbf{v}'_1$.

Second, suppose that $j = 1$. Again, we first show that ν must be uncharged in this case. Regardless of the charge of ν we must have $\mathbf{v} \cdot \mathbf{v}_1 = 1$, otherwise the degree of ν_1 would be greater than 4. Suppose for a contradiction that ν is charged. The exclusion of triangles containing a single charged vertex means that \mathbf{v} is orthogonal to both \mathbf{v}_0 and \mathbf{v}_2 . But then G contains a subgraph equivalent to X_{15} , which is impossible; hence ν must be uncharged. Since we have excluded uncharged triangles, \mathbf{v} must be orthogonal to both \mathbf{v}_0 and \mathbf{v}_2 . Using equation (4.2), we find that $(\mathbf{v} - \mathbf{v}'_2) \cdot (\mathbf{v} - \mathbf{v}'_2) = 0$. Hence $\mathbf{v} = \mathbf{v}'_2$.

We have that the vertices ν_0 and ν_1 are P'_{2r+1} -saturated in P_{2r+1} . If $r = 2$ then we are done. We assume that $r > 2$ and that, for $1 < t < r$ and $0 \leq j < t$, each vertex $\nu_j \in V'_4(P_{2r+1})$ is P'_{2r+1} -saturated in P_{2r+1} . It suffices now to show that ν_t is P'_{2r+1} -saturated in P_{2r+1} . Suppose a vertex $\nu \in V(G) \setminus V(P_{2r+1})$ is adjacent to ν_t . We split into cases.

Case 1. ν is adjacent to ν_{t-2} . By our inductive hypothesis, ν_{t-2} is P'_{2r+1} -saturated in P_{2r+1} and thus \mathbf{v} is switch-equivalent to the Gram vector of some hollow vertex. Moreover, the hollow vertex in question must be adjacent to both ν_t and ν_{t-2} . Hence \mathbf{v} is switch-equivalent to \mathbf{v}'_{t-1} .

Case 2. ν is not adjacent to ν_{t-2} . Then $\mathbf{v} \cdot \mathbf{v}_{t-2} = 0$. Suppose for a contradiction that ν has a charge of ± 1 . The exclusion of triangles containing a single charged vertex means that \mathbf{v} is orthogonal to both \mathbf{v}_{t-1} and \mathbf{v}_{t+1} . But then G contains a subgraph equivalent to either X_{18} or X_{19} , which is forbidden. Hence we can assume that ν is uncharged.

Since uncharged triangles are excluded, \mathbf{v} is orthogonal to \mathbf{v}_{t-1} and \mathbf{v}_{t+1} . And we must have $\mathbf{v} \cdot \mathbf{v}_t = 1$ since we have excluded X_{16} and X_{17} . Now, our inductive hypothesis says that if ν is adjacent to a vertex $\nu_k \in V'_4(P_{2r+1})$ where $0 \leq k < t$ then \mathbf{v} is switch-equivalent to the Gram vector of some hollow vertex. But for $0 \leq k \leq t-3$ there are no hollow vertices adjacent to both ν_k and ν_t . Therefore \mathbf{v} must be orthogonal to all of $\mathbf{v}_0, \mathbf{v}_1, \dots, \mathbf{v}_{t-3}$. By Lemma 4.8, the vector \mathbf{v}'_{t-1} is a linear combination of the Gram vectors $\mathbf{v}_0, \mathbf{v}_1, \dots, \mathbf{v}_{t-1}$, and hence $\mathbf{v}'_{t-1} \cdot \mathbf{v} = 0$. By Lemma 3.8 we can write

$$2\mathbf{v}_t = \mathbf{v}_{t-1} - \mathbf{v}'_{t-1} + \mathbf{v}_{t+1} + \mathbf{v}'_{t+1}. \quad (4.3)$$

From the dot product of \mathbf{v} and equation (4.3), it follows that $\mathbf{v} = \mathbf{v}'_{t+1}$ as required. \blacksquare

Let G be an \mathcal{L}_4 -free $\mathbb{Z}[\sqrt{2}]$ -graph containing P_{2r+1} with $r \geq 2$. By the symmetry of P'_{2r+1} , it follows from Lemma 4.9 that each vertex in $V'_4(\mathcal{V}_G(P_{2r+1}))$ is P'_{2r+1} -saturated in $\mathcal{V}_G(P_{2r+1})$.

Lemma 4.10. *Let G be an \mathcal{L}_4 -free $\mathbb{Z}[\sqrt{2}]$ -graph containing P_{2r+1} with $r \geq 2$, where v_r is adjacent to a vertex $v \in V(G) \setminus \mathcal{V}_G(P_{2r+1})$.*

- (i) *If v is uncharged then either G is contained in $C_{2(r+1)}$ or G contains $P_{2(r+1)+1}$.*
- (ii) *If v is charged then G is contained in $C_{2(r+1)+1}$.*

Proof. Without loss of generality, we have either $\mathbf{v} \cdot \mathbf{v}_r = 1$ or $\mathbf{v} \cdot \mathbf{v}_r = \sqrt{2}$. By Lemma 3.8 we have

$$2\mathbf{v}_{r-1} = \mathbf{v}_{r-2} - \mathbf{v}'_{r-2} + \mathbf{v}_r + \mathbf{v}'_r. \quad (4.4)$$

By Lemma 4.8, for $j \in \{1, \dots, r-1\}$, we can write \mathbf{v}'_j as a linear combination of the Gram vectors $\mathbf{v}_0, \dots, \mathbf{v}_j$ and according to Lemma 4.9, the vertices v_0, \dots, v_{r-1} are P'_{2r+1} -saturated in P_{2r+1} . Since $v \notin \mathcal{V}_G(P_{2r+1})$, we have $\mathbf{v} \cdot \mathbf{v}_j = 0$ for $j \in \{0, \dots, r-1\}$. Therefore, by Lemma 4.8, \mathbf{v} is orthogonal to \mathbf{v}'_j for all $j \in \{1, \dots, r-1\}$. Hence, in particular, \mathbf{v} is orthogonal to \mathbf{v}_{r-1} , \mathbf{v}_{r-2} , and \mathbf{v}'_{r-2} . Take the dot product of \mathbf{v} and equation (4.4) to give $\mathbf{v} \cdot \mathbf{v}_r = -\mathbf{v} \cdot \mathbf{v}'_r$. Now, we begin by proving (i). Suppose that v is uncharged.

Case 1. $\mathbf{v} \cdot \mathbf{v}_r = \sqrt{2}$. By above, we have $\mathbf{v} \cdot \mathbf{v}'_r = -\sqrt{2}$.

In order to show that G is contained in $C_{2(r+1)}$, we need to show that every vertex of $V(P_{2r+1}) \cup \{v\}$ is $(P'_{2r+1} \cup \{v\})$ -saturated in $P_{2r+1} \cup \{v\}$. By Lemma 4.9, this immediately reduces to showing that both v and v_r are $(P'_{2r+1} \cup \{v\})$ -saturated in $P_{2r+1} \cup \{v\}$.

First we treat v . Suppose that a vertex $x \in V(G) \setminus V(P_{2r+1} \cup \{v\})$ is adjacent to v . We rule out the possibility of x having a charge as follows. If x were charged then the exclusion of triangles containing a single charge gives us that \mathbf{x} is orthogonal to \mathbf{v}_r . And since X_{13} and Y_4 are excluded, \mathbf{x} must be orthogonal to \mathbf{v}_{r-1} . But this means that G would contain a subgraph equivalent to X_{12} , which is forbidden. Hence we assume x is uncharged. The excluded subgraphs X_2, X_3, X_8 , and Y_{11} force x to be adjacent to the vertex v_{r-1} , which is $(P'_{2r+1} \cup \{v\})$ -saturated in $P_{2r+1} \cup \{v\}$. Therefore \mathbf{x} is switch-equivalent to \mathbf{v}'_r .

To complete Case 1, we show that v_r is $(P'_{2r+1} \cup \{v\})$ -saturated in $P_{2r+1} \cup \{v\}$. Suppose that $x \in V(G) \setminus V(P_{2r+1} \cup \{v\})$ is adjacent to v_r . If x were charged then G would contain a subgraph equivalent to X_{15}, Y_4 , or a triangle containing exactly one charged vertex. Hence we can assume that x is uncharged. Since all possible uncharged triangles have been excluded, we have that \mathbf{x} is orthogonal to both \mathbf{v}_{r-1} and \mathbf{v} . And the excluded subgraphs X_{14}, X_{16} , and X_{17} force x to be adjacent to the vertex v_{r-2} , which is $(P'_{2r+1} \cup \{v\})$ -saturated in $P_{2r+1} \cup \{v\}$. Therefore \mathbf{x} is switch-equivalent to \mathbf{v}'_{r-1} . We have shown that both v and

v_r are $P'_{2r+1} \cup \{v\}$ -saturated in $P_{2r+1} \cup \{v\}$. Hence, as in the proof of Lemma 3.19, we have that G is equivalent to a subgraph of $C_{2(r+1)}$.

Case 2. $\mathbf{v} \cdot \mathbf{v}_r = 1$. By above, we have $\mathbf{v} \cdot \mathbf{v}'_r = -1$. We have established a subgraph of G equivalent to $P_{2(r+1)+1}$.

For (ii) we suppose that v is charged. We can assume that v has charge -1 . From the exclusion of Y_4 we have that $\mathbf{v} \cdot \mathbf{v}_r = 1$. Hence, the above yields $\mathbf{v} \cdot \mathbf{v}'_r = -1$.

Let v' be a hollow vertex of charge -1 that is adjacent to v with edge-weight 1. Then we can write $\mathbf{v}' = \mathbf{v}$ and hence v' has the same adjacency as v . It suffices to show that every vertex of $V(P_{2r+1}) \cup \{v\}$ is $(P'_{2r+1} \cup \{v, v'\})$ -saturated in $P_{2r+1} \cup \{v\}$. This immediately reduces to showing that both v and v_r are $(P'_{2r+1} \cup \{v, v'\})$ -saturated in $P_{2r+1} \cup \{v\}$.

First we show that v is $(P'_{2r+1} \cup \{v, v'\})$ -saturated in $P_{2r+1} \cup \{v\}$. Suppose a vertex $x \in V(G) \setminus V(P_{2r+1} \cup \{v\})$ is adjacent to v . The excluded subgraphs X_1, Y_4 , and Y_6 mean that we must have $\mathbf{x} \cdot \mathbf{v} = 1$. If x is uncharged then, since X_{11} has been excluded along with triangles having a single charge, x must be adjacent to the vertex v_{r-1} , which is $(P'_{2r+1} \cup \{v, v'\})$ -saturated in $P_{2r+1} \cup \{v\}$. Hence \mathbf{x} is switch-equivalent to \mathbf{v}'_r . Otherwise, suppose x is charged. Since we have excluded Y_1, Y_2 , and Y_5 , the charge of x must be -1 . The dot product $(\mathbf{x} - \mathbf{v}') \cdot (\mathbf{x} - \mathbf{v}') = 0$ and hence \mathbf{x} is switch-equivalent to \mathbf{v}' .

It remains to show that v_r is $(P'_{2r+1} \cup \{v, v'\})$ -saturated in $P_{2r+1} \cup \{v\}$. Suppose that $x \in V(G) \setminus V(P_{2r+1} \cup \{v\})$ is adjacent to v_r . If x is uncharged then, since all possible triangles having at most a single charged vertex have been excluded, we have that \mathbf{x} is orthogonal to both \mathbf{v}_{r-1} and \mathbf{v} . And the excluded subgraphs X_{15}, X_{18} , and X_{19} force x to be adjacent to the vertex v_{r-2} , which is $(P'_{2r+1} \cup \{v, v'\})$ -saturated in $P_{2r+1} \cup \{v\}$. Therefore \mathbf{x} is switch-equivalent to \mathbf{v}'_{r-1} .

Otherwise, suppose that x is a charged vertex. Since we have excluded Y_4, Y_7 , and Y_8 , we must have x adjacent to v , which is $(P'_{2r+1} \cup \{v, v'\})$ -saturated in $P_{2r+1} \cup \{v\}$. Hence \mathbf{x} is switch-equivalent to \mathbf{v}' . We have shown that both v and v_r are $(P'_{2r+1} \cup \{v, v'\})$ -saturated in $P_{2r+1} \cup \{v\}$. As in the proof of Lemma 3.23, we have that G is equivalent to a subgraph of $C_{2(r+1)+1}$. ■

4.3.3 \mathcal{L}_4 -free $\mathbb{Z}[\sqrt{2}]$ -graphs on up to 5 vertices

Let G be an \mathcal{L}_4 -free $\mathbb{Z}[\sqrt{2}]$ -graph. If G does not contain an edge with an irrational weight then G has been classified in Theorem 4.2. Since G is cyclotomic, it cannot contain an edge whose weight squares to more than 4. We have excluded X_1, Y_1, \dots, Y_6 , so we can

assume that G contains an edge of weight $\sqrt{2}$ incident at two uncharged vertices. Define H_0 to be the uncharged $\mathbb{Z}[\sqrt{2}]$ -graph on two vertices having an edge of weight $\sqrt{2}$.

Growing process

Start with our edge with weight $\sqrt{2}$ which we named above H_0 . Consider all possible ways of adding a vertex to H_0 such that the resulting graph H' is an \mathcal{L}_4 -free $\mathbb{Z}[\sqrt{2}]$ -graph. (Note that the resulting graph need not be cyclotomic.) Repeat this process with all supergraphs H' until all such $\mathbb{Z}[\sqrt{2}]$ -graphs on the desired number of vertices have been obtained. We have exhaustively computed all such graphs on up to 5 vertices. Out of these graphs, each one on 5 vertices contains a subgraph equivalent to P_5 (which has 3 vertices).

By the above computation and by iteratively applying Lemma 4.10 we have the following lemma.

Lemma 4.11. *Let G be an \mathcal{L}_4 -free $\mathbb{Z}[\sqrt{2}]$ -graph having at least one irrational edge-weight. Then G is equivalent to a subgraph of C_{2k} and C_{2k-1} for some $k \geq 2$.*

Together with the computation of the maximal connected cyclotomic $\mathbb{Z}[\sqrt{2}]$ -graphs containing the excluded subgraphs of type II in Figure 4.10, we have proved Theorem 4.3.

4.4 Applying Perron-Frobenius theory

As opposed to imaginary quadratic integer rings, by working with Hermitian matrices over real quadratic integer rings, we lose the nice property of having a guaranteed integral characteristic polynomial (which we had in the last chapter) but we gain the use of the Perron-Frobenius Theorem which we state below.

4.4.1 The Perron-Frobenius Theorem

We used the Perron-Frobenius Theorem in Chapter 2 and we restate it here along with some definitions. The **spectral radius** $\rho(A)$ of a square matrix A is the maximum of the moduli of its eigenvalues. We define the spectral radius $\rho(G)$ of the graph G corresponding to A to be the spectral radius of A . A real matrix is called **nonnegative** if all its entries are nonnegative and a graph is called nonnegative if it has a nonnegative adjacency matrix. Let A and B be real symmetric matrices of dimension n and m respectively with $n \geq m$. We write $A \geq B$ if A contains a principal submatrix such that $A - B$ is nonnegative; the

inequality is strict unless $A = B$. For the graphs G and H corresponding to A and B respectively, we write $G \geq H$.

Theorem 4.12 (Perron-Frobenius Theorem). [14, Theorem 8.8.1] Suppose A is an indecomposable nonnegative $n \times n$ matrix. Then:

- (a) The spectral radius $\rho = \rho(A)$ is a simple eigenvalue of A and an eigenvector \mathbf{x} is an eigenvector for ρ if and only if no entries of \mathbf{x} are zero, and all have the same sign.
- (b) Suppose A' is a nonnegative $n \times n$ matrix such that $A - A'$ is nonnegative. Then $\rho(A') \leq \rho(A)$ with equality if and only if $A = A'$;

Remark. Suppose G is a connected graph and H is a nonnegative graph. An implication of Perron-Frobenius together with interlacing is that if $G > H$ then $\rho(G) > \rho(H)$. The nonnegative graphs $P_n^{(1)}$ (for $n \geq 3$), $P_n^{(2)}$ (for $n \geq 2$), $P_n^{(3)}$ (for $n \geq 2$), and Q_n (for $n \geq 3$) in Figure 4.11 have an eigenvalue of 2 corresponding to an eigenvector given by the numbers beneath their vertices. By Theorem 4.12, since the eigenvectors given are positive, the graphs $P_n^{(1)}$ (for $n \geq 3$), $P_n^{(2)}$ (for $n \geq 2$), $P_n^{(3)}$ (for $n \geq 2$), and Q_n (for $n \geq 3$) all have spectral radius 2.

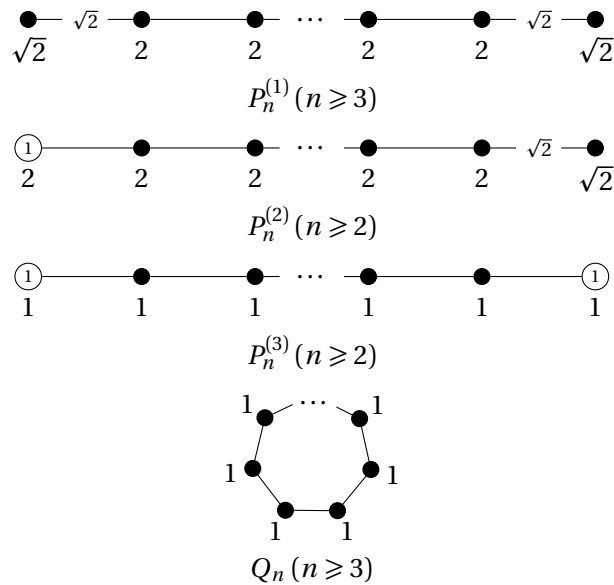

Figure 4.11: Four infinite families of nonnegative cyclotomic $\mathbb{Z}[\sqrt{2}]$ -graphs each having spectral radius 2. The numbers on the vertices correspond to an eigenvector with largest eigenvalue 2. The subscript is the number of vertices.

4.4.2 Cyclotomic matrices over \mathcal{R}

In this section we prove that all matrices in \mathfrak{S}'_n are necessarily symmetric matrices over one of the rings \mathbb{Z} , $\mathbb{Z}[\sqrt{2}]$, $\mathbb{Z}[\varphi]$, or $\mathbb{Z}[\sqrt{3}]$. Set $R = \mathcal{R}$, the compositum of real quadratic integer rings, and let K be the normal closure of the field generated by elements of R over \mathbb{Q} . Let A be an R -matrix in \mathfrak{S}'_n and let G be its corresponding R -graph. By Corollary 1.8, we need only consider entries of A from the set $R' = \{0, \pm 1, \pm\sqrt{2}, \pm\varphi, \pm\bar{\varphi}, \pm\sqrt{3}, \pm 2\}$; these are the only real algebraic integers from R whose conjugates all square to at most 4. For a typical element $x \in \mathcal{R}$, its square has the form

$$x^2 = a_1^2 + 2a_2^2 + 3a_3^2 + a_5^2 + 2a_{2,5}^2 + 3a_{3,5}^2 + 3a_{13}^2 + 3a_{5,13}^2 + 4a_{17}^2 + 4a_{5,17}^2 + S + L,$$

where the a 's are rational integers, S is a linear combination of integer squares each having coefficient greater than 4, and L is an element of $\mathcal{R} \setminus \mathbb{Z}$.

We claim that, for each element $x \in \mathcal{R} \setminus \mathbb{Z}$ there exists an automorphism $\sigma \in \text{Gal}(K/\mathbb{Q})$ such that $\sigma(x) \geq 0$. Define

$$\omega_d = \begin{cases} \sqrt{d}, & \text{if } d \equiv 2, 3 \pmod{4} \\ \frac{1+\sqrt{d}}{2}, & \text{if } d \equiv 1 \pmod{4}. \end{cases}$$

Let X_k denote the subset of elements of $\mathcal{R} \setminus \mathbb{Z}$ that can be expressed (over \mathbb{Z}) in no fewer than k different ω_d . Any element $y \in X_1 \setminus X_2$ has the form $a\omega_d$ for some $a \in \mathbb{Z}$ and some squarefree $d \geq 2$. If y is negative then we can apply an automorphism that sends \sqrt{d} to $-\sqrt{d}$. Now suppose that the claim is true for each element of the set $X_k \setminus X_{k+1}$. Any element $y \in X_{k+1} \setminus X_{k+2}$ can be written as $\alpha_1 + \omega_d \alpha_2$, for some squarefree $d \geq 2$ where $\alpha_1 \in X_k \setminus X_{k+1}$, $\alpha_2 \in (\mathbb{Z} + (X_k \setminus X_{k+1}))$, and ω_d is not part of the expression of either α_1 or α_2 . By our inductive hypothesis, we can apply an automorphism to make α_1 nonnegative. If necessary, we can apply an automorphism sending \sqrt{d} to $-\sqrt{d}$ to make y nonnegative. Therefore we can assume that L is nonnegative.

Moreover, we can assume that S is zero, otherwise $x^2 > 4$. Apart from the triples $\{a_1, a_2, a_5\}$ and $\{a_1, a_5, a_{2,5}\}$, if at least three of the other a 's are nonzero then the sum

$$a_1^2 + 2a_2^2 + 3a_3^2 + a_5^2 + 2a_{2,5}^2 + 3a_{3,5}^2 + 3a_{13}^2 + 3a_{5,13}^2 + 4a_{17}^2 + 4a_{5,17}^2$$

is greater than 4 and hence $x^2 > 4$. One can check that, for the two triples $\{a_1, a_2, a_5\}$ and $\{a_1, a_5, a_{2,5}\}$ and for nonzero pairs of a 's, the set R' is indeed the set of real algebraic integers from R whose conjugates all square to at most 4. Therefore, without loss of

4. Hermitian Matrices over Real Quadratic Integer Rings

generality, we can take R to be the ring generated by R' over \mathbb{Z} and we can set $K = \mathbb{Q}(\sqrt{2}, \sqrt{3}, \sqrt{5})$

Now we deal with the possibility of G containing a subgraph equivalent to the following graphs:

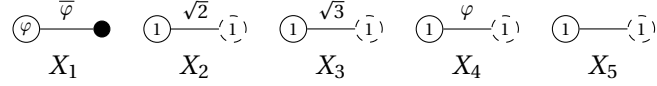

We have exhaustively checked all connected R -supergraphs of X_1 , X_2 , X_3 , X_4 , and X_5 that are in \mathfrak{S}'_n for some n . These supergraphs are all subgraphs of either S_2^\dagger , C_4^{+-} , $S_4^{(1,\varphi)}$, $S_4^{(3,\varphi)}$, $S_4^{(1,\sqrt{2})}$, S_7 , S_8 , or S_8' (see Figures 4.7 and 4.8) and hence are all either $\mathbb{Z}[\sqrt{2}]$ -graphs, $\mathbb{Z}[\sqrt{3}]$ -graphs, or $\mathbb{Z}[\varphi]$ -graphs. This computation can be checked with little effort; we used PARI/GP [29], growing symmetric R -matrices of at most 4 rows. Henceforth we assume that X_1 , X_2 , X_3 , X_4 , and X_5 are not equivalent to any subgraph of G . We can also exclude ± 2 from being an entry of our matrix A since, by Corollary 1.8, any connected graph properly containing either S_1 or S_2 is not in \mathfrak{S}'_n .

Let A' be a smallest principal submatrix of A with respect to having at least two irrational entries α and β such that its corresponding R -graph G' is connected. Suppose α is not conjugate to $\pm\beta$, i.e., α and $\pm\beta$ do not have the same minimal polynomial. We will show that this supposition violates the condition that A is in \mathfrak{S}'_n . We can assume that at least one of α and β (say α) is not equal to $\pm\sqrt{2}$. Observe that, by a combination of switching and Galois conjugation (using automorphisms from $\text{Gal}(K/\mathbb{Q})$), we can make all the edge-weights of G' positive and hence we assume that all the off-diagonal entries of A' are nonnegative.

If G' is a triangle then, since we have excluded the subgraphs X_1 , X_2 , X_3 , X_4 , and X_5 , we can find a graph H equivalent to G' that satisfies $H > Q_3$. By the Perron-Frobenius Theorem, the spectral radius of H is strictly greater than 2; hence, by interlacing, A is equivalent to a matrix that is not in \mathfrak{S}'_n . Therefore A is not in \mathfrak{S}'_n . Otherwise, if G' is not a triangle then G' must be a path. Since A' is minimal with respect to the condition of containing both α and β as entries, any induced subpath $p_1 p_2 \dots p_k$ of G' must have $w(p_i, p_{i+1}) = 1$ when i is equal to neither 1 nor $k - 1$. Moreover, the minimality also implies that the charge of p_j for $j \in \{2, \dots, k - 1\}$ is either 0 or ± 1 .

We consider two cases for G' : the case where G' is uncharged and the case where G' has a charge. In the first case we have $H > P_n^{(1)}$ for some n and in the second, we have either $H > P_n^{(2)}$ or $H > P_n^{(3)}$ for some n where, in each case, H is an R -graph that is equivalent to G' . By the Perron-Frobenius Theorem, the spectral radius of H is strictly

greater than 2 and hence, by interlacing, A is not in \mathfrak{S}'_n . Therefore, we have established the following result.

Proposition 4.13. *Let A be an indecomposable \mathcal{R} -matrix having as entries two irrational integers α and β with α not conjugate to $\pm\beta$. Then A is not in \mathfrak{S}'_n .*

Theorem 4.6 follows immediately.

4.4.3 Elements of $\mathfrak{S}'_n \setminus \mathfrak{S}_n$

Here we give a proof of Corollary 4.7 and enumerate all elements in $\mathfrak{S}'_n \setminus \mathfrak{S}_n$ for $n \leq 6$. In Table 4.2, we have tabulated the number of elements of the set $\mathfrak{S}'_n \setminus \mathfrak{S}_n$ for $n \leq 6$, these are given working up to equivalence. With respect to Theorem 4.6, we have also recorded the number of elements in $\mathfrak{S}'_n \setminus \mathfrak{S}_n$ that lie in each $\mathcal{O}_{\mathbb{Q}(\sqrt{d})}$ -matrix ring for $d > 1$. We remark that all elements of \mathfrak{S}'_n are contained in some maximal cyclotomic matrix. Since all subgraphs of the infinite families of maximal cyclotomic matrices are in \mathfrak{S}_n , one can find elements $\mathfrak{S}'_n \setminus \mathfrak{S}_n$ by checking subgraphs of the sporadic maximal cyclotomic matrices.

n	$ \mathfrak{S}'_n \setminus \mathfrak{S}_n $	$\mathbb{Z}[\varphi]$	$\mathbb{Z}[\sqrt{2}]$	$\mathbb{Z}[\sqrt{3}]$
1	3	1	1	1
2	7	6	1	0
3	4	3	1	0
4	6	6	0	0
5	4	4	0	0
6	1	1	0	0

Table 4.2: Up to equivalence, the number of elements of the set $\mathfrak{S}'_n \setminus \mathfrak{S}_n$ for $n \leq 6$.

Now we give a lemma resembling the crystallographic criterion for a Coxeter graph, see Humphreys [17, Proposition 6.6].

Lemma 4.14. *Let $A \in \mathfrak{S}'_n$ be a $\mathbb{Z}[\sqrt{2}]$ -matrix having all its charges in \mathbb{Z} and let G be its associated graph. Then every cycle of G has an even number of edges of weight $\pm\sqrt{2}$. Hence A is in \mathfrak{S}_n .*

Proof. Let σ be the nontrivial automorphism of $\mathbb{Z}[\sqrt{2}]$ which sends $\sqrt{2}$ to $-\sqrt{2}$. Suppose for a contradiction that G contains a cycle having an odd number of edges with weight $\pm\sqrt{2}$ and let C be a smallest such cycle.

Case 1. C is uncharged. In this case we can switch either C or $\sigma(C)$ in such a way that the resulting nonnegative cycle C' has $C' > Q_k$ for some k . Hence, $\rho(C') > \rho(Q_k) = 2$ and so, by interlacing, we have $\rho(A) \geq \rho(C') > \rho(Q_k) = 2$.

Case 2. C is charged. As in the previous section we can exclude X_2 and X_5 as subgraphs of G . In the case when C is a triangle, one can find an equivalent cycle C' satisfying $C' > Q_3$. If C is a quadrangle then C is equivalent to a cycle C' which satisfies $C' > P_k^{(2)}$ or $C' > P_k^{(3)}$ for some k or contains a path P satisfying $P > P_2^{(2)}$ or $P > P_2^{(3)}$. Otherwise, C contains a subpath equivalent to a path C' where either $C' > P_k^{(2)}$ or $C' > P_k^{(3)}$ for some k . Therefore, in each case, $A \notin \mathfrak{S}'_n$ which is a contradiction.

On the other hand, it can be readily seen that if all the cycles of G have an even number of edges of weight $\pm\sqrt{2}$, then G is Galois invariant. ■

Finally, we give a proof of Corollary 4.7.

Proof (Corollary 4.7). We have computed all the sets \mathfrak{S}'_n and \mathfrak{S}_n for $n \leq 8$. We have that $\mathfrak{S}'_7 = \mathfrak{S}_7$ and $\mathfrak{S}'_8 = \mathfrak{S}_8$. By computation and Proposition 4.13, we know that all matrices in \mathfrak{S}'_n for $n > 8$ are $\mathbb{Z}[\sqrt{2}]$ -matrices. Thus, it suffices to consider only $\mathbb{Z}[\sqrt{2}]$ -matrices. From our computation we know that all $\mathbb{Z}[\sqrt{2}]$ -matrices in \mathfrak{S}'_5 have all their charges in \mathbb{Z} , hence, by interlacing, the same must be true for the sets \mathfrak{S}'_k for all $k > 5$. The result then follows from Lemma 4.14. ■

4.5 Lehmer's problem

In this section we turn our attention towards Lehmer's problem. We would like to find a bound $\varepsilon > 0$ such that, if $M(R_A) > 1$ then $M(R_A) \geq 1 + \varepsilon$ where A is a Hermitian matrix over a real quadratic integer ring. We prove the following theorem.

Theorem 4.15. *Let A be a Hermitian matrix over a real quadratic integer ring such that $R_A(z) \in \mathbb{Z}[z]$. Then $M(R_A) = 1$ or $M(R_A) \geq \tau_0$.*

4.5.1 Preliminaries

For the reader's convenience, we give definitions similar to those in Section 3.7.1. For later use we record an obvious fact that follows from the classification of cyclotomic $\mathbb{Z}[\sqrt{2}]$ -matrices.

Corollary 4.16. *Any connected cyclotomic $\mathbb{Z}[\sqrt{2}]$ -graph that is equivalent to a subgraph of T_{2k} , C_{2k} , C_{2k+1} , C_{2k}^{++} , or C_{2k}^{+-} is strongly equivalent to a subgraph of T_{2k} , C_{2k} , $\pm C_{2k+1}$, $\pm C_{2k}^{++}$, or C_{2k}^{+-} .*

There are two types of maximal cyclotomic \mathcal{R} -graphs.

The **sporadics**: $S_1, S_2, S'_2, S_2^\dagger, S_2^\ddagger, S_3, S_4, S_4^{(\sqrt{3})}, S_4^{(1,\varphi)}, S_4^{(2,\varphi)}, S_4^{(3,\varphi)}, S_4^{(1,\sqrt{2})}, S_4^{(2,\sqrt{2})}, S_4^{(3,\sqrt{2})}, S_6, S_7, S_8, S'_8, S_8^\dagger, S_8^{\dagger\dagger}, S_8^\ddagger, S_{14}$, and S_{16} ; see Figures 4.5, 4.6, 4.7, and 4.8.

The **non-sporadics**: $T_{2k}(k \geq 3)$, $C_{2k}(k \geq 2)$, $C_{2k}^{++}(k \geq 2)$, $C_{2k}^{+-}(k \geq 2)$, and $C_{2k+1}(k \geq 1)$; see Figures 4.1, 4.2, 4.3, and 4.4.

A graph is called **minimal non-cyclotomic** if it has at least one eigenvalue lying outside of the interval $[-2, 2]$ and is minimal in that respect, i.e., all of its subgraphs have their eigenvalues contained in $[-2, 2]$. Therefore all minimal non-cyclotomic graphs are connected and, hence, their adjacency matrices are indecomposable. A graph is called **non-supersporadic** if all of its proper connected subgraphs are equivalent to subgraphs of non-sporadics and **supersporadic** otherwise.

Given a graph G , a path (respectively cycle) P is called **chordless** if the subgraph of G induced on the vertices of P is a path (respectively cycle). Define the **path rank** of G to be the maximal number of vertices in a chordless path or cycle of G . We say that G has a **profile** if its vertices can be partitioned into a sequence of $k \geq 3$ subsets $\mathcal{C}_0, \dots, \mathcal{C}_{k-1}$ such that either

- two vertices v and w are adjacent if and only if $v \in \mathcal{C}_{j-1}$ and $w \in \mathcal{C}_j$ for some $j \in \{1, \dots, k-1\}$ or v and w are both charged vertices in the same subset

or

- two vertices v and w are adjacent if and only if $v \in \mathcal{C}_{j-1}$ and $w \in \mathcal{C}_j$ for some $j \in \mathbb{Z}/k\mathbb{Z}$ or v and w are both charged vertices in the same subset.

In the latter case, we say that the profile is **cyclings**. Given a graph G with a profile $\mathcal{C} = (\mathcal{C}_0, \dots, \mathcal{C}_{k-1})$ we define the **profile rank** of G to be k , the number of subsets in the profile \mathcal{C} .

By interlacing, each minimal non-cyclotomic matrix A on at least two rows contains a submatrix B such that $M(R_B) = 1$. Hence in order to get a lower bound for $M(R_A) > 1$ where A is a Hermitian matrix over a real quadratic integer ring, we can test the Mahler

measures of R_A where A is a matrix that contains a matrix in \mathfrak{S}'_n for some n . As it currently stands, we need to test an infinite number of matrices. But we will reduce the work so that it suffices to test all the supersporadic graphs (of which there are only finitely many) and the non-supersporadic graphs on up to 8 vertices.

4.5.2 Reduction to a finite search

In this section we reduce the search for minimal non-cyclotomic matrices to a finite one. The only real quadratic integer ring that gives rise to infinite families of maximal cyclotomic matrices is $\mathbb{Z}[\sqrt{2}]$, and hence, in this section we will consider matrices over this ring only.

Let A be a Hermitian $\mathbb{Z}[\sqrt{2}]$ -matrix with $R_A(z) \in \mathbb{Z}[z]$. As mentioned in the introduction, Lehmer's problem has been solved for Hermitian \mathbb{Z} -matrices. Hence to find a lower bound for $M(R_A) > 1$, we can assume that A contains at least one irrational entry.

Lemma 4.17. *Let A be a Hermitian $\mathbb{Z}[\sqrt{2}]$ -matrix with $R_A(z) \in \mathbb{Z}[z]$ having an entry a such that $|\sigma(a)| > 2$ for some $\sigma \in \text{Gal}(\mathbb{Q}(\sqrt{2})/\mathbb{Q})$. Then $M(R_A) > \tau_0$.*

Proof. Since the Mahler measure of R_A is preserved under equivalence, we may assume that $a > 2$. If a is on the diagonal of A then, by interlacing, the largest eigenvalue of A is at least a . Otherwise, suppose that a is on the off-diagonal, i.e., $a_{jk} = a$ for some $j \neq k$. Then the j th diagonal entry of A^2 is at least a^2 and hence, by interlacing, the largest eigenvalue of A^2 is at least a^2 . Therefore, in either case, the largest eigenvalue of A is at least a .

Let ρ be the spectral radius of A . At least one zero of R_A is given by $\alpha(\rho) = (\rho + \sqrt{\rho^2 - 4})/2$. Up to conjugation, the smallest modulus of an element of $\mathbb{Z}[\sqrt{2}]$ that is greater than 2 is $1 + \sqrt{2}$. Hence it is clear that $|\alpha(\rho)| > \tau_0$. ■

By the above lemma, in order to settle Lehmer's conjecture for polynomials R_A , we need only consider matrices such that each entry a satisfies $|\sigma(a)| \leq 2$ for all automorphisms $\sigma \in \text{Gal}(\mathbb{Q}(\sqrt{2})/\mathbb{Q})$.

Lemma 4.18. *Let A be a non-cyclotomic $\mathbb{Z}[\sqrt{2}]$ -matrix having at least one entry of modulus 2. Then $M(R_A) \geq (\sqrt{5} + 1)/2 > \tau_0$.*

Proof. Since the Mahler measure of R_A is preserved under equivalence, we may assume that A has an entry $a_{jk} = 2$.

Case 1. Suppose $j = k$. Since the 1×1 matrix (2) is cyclotomic, A has at least two rows and hence contains as a principal submatrix the matrix

$$\begin{pmatrix} 2 & a \\ a & b \end{pmatrix}.$$

Since A is indecomposable, it is possible to choose a to be nonzero. Therefore, the j th diagonal entry of A^2 is at least $4 + a^2$, and hence the spectral radius ρ of A is at least $\sqrt{4 + a^2}$. Now, for all nonzero $a \in \mathbb{Z}[\sqrt{2}]$, we have $a^2 \geq 1$ and so we have the following inequality

$$\rho \geq \sqrt{4 + a^2} \geq \sqrt{5}.$$

Hence, the associated reciprocal polynomial R_A has a zero with absolute value at least $(\sqrt{5} + 1)/2$. Therefore $M(R_A) \geq (\sqrt{5} + 1)/2 > \tau_0$.

Case 2. Suppose $j \neq k$. Then A contains as a principal submatrix the matrix

$$\begin{pmatrix} a & 2 \\ 2 & b \end{pmatrix}.$$

If either a or b are nonzero then by the same argument as before $M(R_A) \geq (\sqrt{5} + 1)/2 > \tau_0$. Otherwise, if both a and b are zero, since

$$\begin{pmatrix} 0 & 2 \\ 2 & 0 \end{pmatrix}$$

is cyclotomic, A contains as a principal submatrix the matrix

$$\begin{pmatrix} 0 & 2 & c \\ 2 & 0 & d \\ c & d & e \end{pmatrix}.$$

Since A is indecomposable, we can choose this submatrix so that at least one of c and d is nonzero. By applying the same argument as before we obtain the inequality

$$M(R_A) \geq (\sqrt{5} + 1)/2 > \tau_0. \quad \blacksquare$$

By Lemma 4.17 and Lemma 4.18, instead of $\mathbb{Z}[\sqrt{2}]$, we can just consider the set $S = \{0, \pm 1, \pm \sqrt{2}\}$.

Lemma 4.19. *Let G be an S -graph having a vertex of degree at least 5 and let A be an adjacency matrix of G . Then $M(R_A) \geq (\sqrt{5} + 1)/2 > \tau_0$.*

Proof. By the proof of Lemma 1.7, the spectral radius of A is at least $\sqrt{5}$. Therefore, as in the previous lemma, $M(R_A) \geq (\sqrt{5} + 1)/2 > \tau_0$. ■

Lemma 4.20. *Let G be an n -vertex ($n \geq 7$) connected S -graph that is equivalent to a subgraph of a non-sporadic graph. Suppose that G does not contain a chordless cycle on more than 4 vertices and suppose that G is not equivalent to a subgraph of T_8 . Then the path rank of G equals its profile rank, and its columns are uniquely determined. Moreover, their order is determined up to reversal.*

Proof. Let P be a chordless path or cycle with maximal number of vertices. If the maximal cycle length is equal to the maximal path length, then take P to be a path. By inspection of the maximal non-sporadic $\mathbb{Z}[\sqrt{2}]$ -graphs, it can be seen that any such subgraph on at least 7 vertices contains a chordless path on at least 4 vertices. By assumption, any chordless cycle of G has at most 4 vertices and hence we take P to be a chordless path with maximal number of vertices, which is at least 4. The columns of the profile of P inherited from that of G are singletons. Because the profile is not cycling, the column to which a new vertex can be added is completely determined by the vertices it is adjacent to in G . ■

Proposition 4.21. *Let G be an n -vertex ($n \geq 9$) connected non-supersporadic S -graph that contains at least one edge-weight $\pm\sqrt{2}$. Suppose that no 7-vertex subgraph of G is equivalent to a subgraph of T_8 . Then G is equivalent to a subgraph of a non-sporadic S -graph.*

Proof. Let G satisfy the assumption of the proposition. Take a chordless path or cycle P of G with maximal number of vertices. If there simultaneously exist chordless paths and chordless cycles in G both containing the maximal number of vertices then we take P to be one of the paths.

Claim 1. *G does not contain a chordless cycle on more than 4 vertices and hence P is a path.*

Consider a connected subgraph G' of G on at least 8 vertices containing an edge of weight $\pm\sqrt{2}$. The subgraph G' is equivalent to a subgraph of C_{2k} or C_{2k+1} for some k and hence it contains a chordless path on at least 4 vertices. Suppose G properly contains a chordless cycle on at least 5 vertices. Since every subgraph of G is cyclotomic, the cycle cannot contain an edge of weight $\pm\sqrt{2}$, and hence an edge-weight $\pm\sqrt{2}$ must be joined to the cycle via some path. Let v be the intersection of the vertices of this path and the cycle.

By deleting a vertex of the cycle that is not a neighbour of v (and not v), we obtain a non-cyclotomic subgraph of G , which is impossible. Otherwise, if G itself is a cycle then G contains a subpath on at least 8 vertices having an edge of weight $\sqrt{2}$ near the middle, one does not find such a graph in the classification of cyclotomic $\mathbb{Z}[\sqrt{2}]$ -graphs, which is a contradiction. Therefore G does not contain a chordless cycle on more than 4 vertices, and hence P is a path.

Let x and y be the endvertices of P .

Claim 2. *The subgraphs $G \setminus \{x\}$, $G \setminus \{y\}$, and $G \setminus \{x, y\}$ are connected.*

If a vertex x' of G is adjacent to x , then it must also be adjacent to another vertex of P otherwise there exists a longer chordless path. It follows that $G \setminus \{x\}$ is connected. This is similar for $G \setminus \{y\}$. Therefore, $G \setminus \{x, y\}$ is also connected and we have proved Claim 2.

Next we show that G has a profile.

Claim 3. *G has a profile.*

The connected subgraphs $G \setminus \{x\}$, $G \setminus \{y\}$, and $G \setminus \{x, y\}$ have at least 7 vertices. And since G does not contain any chordless cycles on more than 4 vertices, by Lemma 4.20, the subgraphs $G \setminus \{x\}$, $G \setminus \{y\}$, and $G \setminus \{x, y\}$ have uniquely determined profiles. By Corollary 4.16, we can switch $G \setminus \{x\}$ to obtain a subgraph G_x of one of T_{2k} , C_{2k} , $\pm C_{2k+1}$, $\pm C_{2k}^{++}$, and C_{2k}^{+-} for some k . We can simultaneously switch $G \setminus \{y\}$ to obtain a subgraph G_y of one of T_{2k} , C_{2k} , $\pm C_{2k+1}$, $\pm C_{2k}^{++}$, and C_{2k}^{+-} for some k , so that $G_x \setminus \{y\}$ and $G_y \setminus \{x\}$ are the same subgraph which we will call G_{xy} . Since it is uniquely determined, the profile of G_x (respectively G_y) can be obtained by the addition of x (respectively y) to the profile of G_{xy} . Now merge the profiles of G_x and G_y to give a sequence of columns \mathcal{C} . We will show that \mathcal{C} is a profile for G .

Let $q \geq 5$ be the number of columns of \mathcal{C} and denote by \mathcal{C}_j the j th column of \mathcal{C} , where \mathcal{C}_{q-1} is the column containing x and \mathcal{C}_0 is the column containing y . Note that for any vertex u in \mathcal{C}_j and vertices v and v' in \mathcal{C}_{j+1} we have that $w(u, v) = w(u, v')$, and for any vertex v in \mathcal{C}_j and vertices u and u' in \mathcal{C}_{j-1} we have that $w(u, v) = -w(u', v)$. Since G does not contain any chordless cycles on more than 4 vertices, no vertex in column \mathcal{C}_0 is adjacent to any vertex of column \mathcal{C}_{q-1} , and hence, \mathcal{C} is a profile for G . Moreover G is equivalent to a subgraph of a non-sporadic graph. ■

4.5.3 Details of the finite search

By Proposition 4.21, as well as minimal non-cyclotomic supergraphs of T_8 , we need only consider supersporadic minimal non-cyclotomic $\mathbb{Z}[\sqrt{2}]$ -graphs and non-supersporadic minimal non-cyclotomic $\mathbb{Z}[\sqrt{2}]$ -graphs on up to 8 vertices. This means we only have a finite search to perform, but we can still reduce the amount of work required to compute the supersporadic minimal non-cyclotomic $\mathbb{Z}[\sqrt{2}]$ -graphs. Since supersporadic minimal non-cyclotomic \mathbb{Z} -graphs have already been classified [26], we need only consider supersporadic minimal non-cyclotomic $\mathbb{Z}[\sqrt{2}]$ -graphs containing at least one irrational edge-weight. This comes down to considering supersporadic minimal non-cyclotomic $\mathbb{Z}[\sqrt{2}]$ -graphs containing an edge of weight $\pm\sqrt{2}$. Each of these graphs can be obtained by attaching a vertex to some connected $\mathbb{Z}[\sqrt{2}]$ -graph that has at least one edge of weight $\pm\sqrt{2}$ and that is a subgraph of a sporadic maximal cyclotomic $\mathbb{Z}[\sqrt{2}]$ -graph. Suppose that G is a supersporadic minimal non-cyclotomic $\mathbb{Z}[\sqrt{2}]$ -graph on at least 10 vertices obtained by attaching a vertex to some connected subgraph G' of a sporadic maximal cyclotomic $\mathbb{Z}[\sqrt{2}]$ -graph that has at least one edge of weight $\pm\sqrt{2}$. Now, G' must be on at least 9 vertices, but there does not exist any such connected $\mathbb{Z}[\sqrt{2}]$ -graph that has an edge of weight $\pm\sqrt{2}$ and that is a subgraph of a sporadic maximal cyclotomic $\mathbb{Z}[\sqrt{2}]$ -graph. Therefore it suffices to check supersporadic minimal non-cyclotomic $\mathbb{Z}[\sqrt{2}]$ -graphs on up to 9 vertices. Thus, together with Proposition 4.21, in order to get a lower bound for $M(R_A)$ where A is a non-cyclotomic S -matrix, it suffices to obtain a lower bound for $M(R_A)$ where A is a non-cyclotomic S -matrix on at most 9 vertices. Recall the set $S = \{0, \pm 1, \pm\sqrt{2}\}$.

Let A be a minimal non-cyclotomic S -matrix. As discussed at the beginning of this chapter, the associated polynomial R_A might not have integer coefficients. If $R_A(z) \notin \mathbb{Z}[z]$, then we check the Mahler measure of $\sigma(R_A)$ for all $\sigma \in \text{Gal}(\mathbb{Q}(\sqrt{2})/\mathbb{Q})$ where σ is applied to the coefficients of R_A . For if some non-cyclotomic S -matrix B contains A as a principal submatrix and $R_B(z) \in \mathbb{Z}[z]$, then the coefficients of R_B are invariant under the Galois automorphisms $\sigma \in \text{Gal}(\mathbb{Q}(\sqrt{2})/\mathbb{Q})$, and hence

$$M(R_B) \geq M(\sigma(R_A)) \text{ for all } \sigma \in \text{Gal}(\mathbb{Q}(\sqrt{2})/\mathbb{Q}).$$

We form a list L of all S -graphs in $\bigcup_{n=1}^8 \mathcal{G}'_n$ on up to 8 vertices each containing at least one irrational edge-weight. We then proceed as follows. For each 1-vertex graph G of L , we consider the set M_G of all possible S -graphs that can be obtained by attaching a vertex to G . Using Lemma 4.19, we can restrict to each graph in M_G having maximum degree at most 4. For A an adjacency matrix, let $\rho(A)$ denote the spectral radius of A , that is, the

4. Hermitian Matrices over Real Quadratic Integer Rings

maximum of moduli of the eigenvalues of A and let $\mathfrak{G} = \text{Gal}(\mathbb{Q}(\sqrt{2})/\mathbb{Q})$. For each graph $H \in M_G$, if an adjacency matrix A_H of H satisfies the inequality

$$2 < \max_{\sigma \in \mathfrak{G}} \rho(\sigma(A_H)) < 2.02 \tag{4.5}$$

then we include H in our list L . Observe that each graph H satisfying the inequality

$$1 < \max_{\sigma \in \mathfrak{G}} M(\sigma(R_H)) < \tau_0$$

must also satisfy equation (4.5). We then repeat this process for 2-vertex graphs, 3-vertex graphs, and so on up to 8-vertex graphs.

We apply the same approach to Hermitian matrices over the rings $\mathbb{Z}[\varphi]$ and $\mathbb{Z}[\sqrt{3}]$. After running the process on each ring R , we found that if A is a Hermitian R -matrix having at least one irrational entry, then either

$$\max_{\sigma \in \mathfrak{G}} \rho(\sigma(A)) = 2 \quad \text{and} \quad \max_{\sigma \in \mathfrak{G}} M(\sigma(R_A)) = 1,$$

or

$$\max_{\sigma \in \mathfrak{G}} \rho(\sigma(A)) > \alpha(R) \quad \text{and} \quad \max_{\sigma \in \mathfrak{G}} M(\sigma(R_A)) > \beta(R),$$

where $\alpha(R)$ and $\beta(R)$ are some constants that depend on R given in Table 4.3 below.

R	$\alpha(R)$	$\beta(R)$
$\mathbb{Z}[\sqrt{2}]$	2.0285	1.2579
$\mathbb{Z}[\varphi]$	2.0237	1.3294
$\mathbb{Z}[\sqrt{3}]$	2.0743	1.5392

Table 4.3: Lower bounds for the spectral radius and Mahler measure of non-cyclotomic matrices over real quadratic integer rings having at least one irrational entry.

The bounds $\beta(R)$ given in Table 4.3 exceed τ_0 . This completes the proof of Theorem 4.15.

Small-Span Hermitian Matrices over Quadratic Integer Rings

Let f be a totally real monic integer polynomial of degree d having as its zeros

$$\alpha_1 \leq \alpha_2 \leq \cdots \leq \alpha_d.$$

The **span** of f is defined to be $\alpha_d - \alpha_1$. In this chapter we build on the work of McKee [23] who classified all integer symmetric matrices whose characteristic polynomials have span less than 4. Following McKee, we call a totally real monic integer polynomial **small-span** if its span is less than 4 and a Hermitian matrix is called small-span if its characteristic polynomial is a small-span polynomial. Irreducible small-span polynomials are of interest since, up to equivalence (described in Section 5.1), there are only finitely many of any given degree [34]. We classify all small-span Hermitian matrices over \mathcal{O}_K for all quadratic number fields K . In doing so, we obtain small-span polynomials as characteristic polynomials of Hermitian \mathcal{O}_K -matrices that are not the minimal polynomial of any Hermitian \mathbb{Z} -matrix. But, as we shall see, there still remain small-span polynomials that are not even minimal polynomials of any Hermitian \mathcal{O}_K -matrix.

5.1 Orientation

Our current area of study has relevance to the question of which integer polynomials are the minimal polynomials of Hermitian matrices over quadratic integer rings. There exists a list, due to Robinson [31], of small-span polynomials up to degree 8 (this list has been extended up to degree 14 [6]). Supposing that we have classified small-span \mathcal{O}_K -matrices, we can check Robinson's list to see which of the polynomials are the minimal polynomial of some Hermitian \mathcal{O}_K -matrix. It was shown in [23] that there exist polynomials of low degree that are not the minimal polynomial of any integer symmetric matrix, the lowest degree being 6. This is a consequence of the classification of small-span \mathbb{Z} -matrices; on

Robinson's list of small-span polynomials, there are three polynomials of degree 6 that are not the minimal polynomials of any small-span integer symmetric matrix and hence of any integer symmetric matrix. As discussed in the introductory chapter, Estes and Guralnick [12] showed that every monic separable totally real integer polynomial of degree at most 4 is the minimal polynomial of some integer symmetric matrix. The question of whether or not, for a monic separable totally real integer polynomial f of degree 5, there exists an integer symmetric matrix having f as its minimal polynomial remains open.

In this chapter, we will use a slightly different notion of equivalence from the notion that we have been using in the previous chapters. Let f and g be totally real monic integer polynomials of degree d with zeros α_j and β_j respectively. We consider f and g to be **equivalent** if, for some $c \in \mathbb{Z}$ and $\varepsilon \in \mathbb{Z}^*$, each $\alpha_j = \varepsilon\beta_j + c$. It is clear that the span is preserved under this equivalence. By setting $\varepsilon = 1$ and $c = \lfloor \alpha_d \rfloor - 2$, one can see that each small-span polynomial is equivalent to a monic integer polynomial whose zeros are contained inside the interval $[-2, 3)$. Moreover, suppose that f is a small-span polynomial with $2.5 \leq \alpha_d < 3$. Setting $\varepsilon = -1$ and $c = 1$, one can see that, in fact, f and hence each small-span polynomial, is equivalent to a monic integer polynomial whose zeros are contained inside the interval $[-2, 2.5)$.

We redefine matrix equivalence so that two matrices A and B are **equivalent** if A is strongly equivalent to $\pm B + cI$ for some $c \in \mathbb{Z}$. (The notion of strong equivalence remains unchanged.) Observe that two small-span \mathcal{O}_K -matrices are equivalent precisely when their characteristic polynomials are equivalent. Each small-span \mathcal{O}_K -matrix is equivalent to one whose eigenvalues are contained inside the interval $[-2, 2.5)$.

In 1983, Petrović [30] effectively classified all simple graphs having a characteristic polynomial of small-span. Actually his classification was of all simple graphs minimal with respect to having a characteristic polynomial of span more than 4. McKee [23] has recently classified all small-span integer symmetric matrices and, as part of the proof, he obtained the following result which we shall put to use later.

Lemma 5.1. *Let G be a small-span \mathbb{Z} -graph on more than 12 vertices. Then G is cyclotomic.*

5.2 Computation of small-span matrices of up to 8 rows

In this section we describe our computations and deduce some restrictions to make the computations feasible.

As a consequence of interlacing (Theorem 1.6) we have the following corollary.

Corollary 5.2. *Let A be an $n \times n$ Hermitian matrix with $n \geq 2$ and let B be an $(n-1) \times (n-1)$ principal submatrix. Then the span of A is at least as large as the span of B . Moreover, if A has all its eigenvalues in the interval $[-2, 2.5)$, then so does B .*

In view of this corollary, given a matrix that contains a matrix that it not equivalent to a small-span matrix having all of its eigenvalues in the interval $[-2, 2.5)$, we can instantly disregard it since it is not a small-span matrix.

Using interlacing we can rapidly restrict the possible entries for the matrices that are of interest to us. This is just a trivial modification of a lemma [23, Lemma 4] used in the classification of small-span integer symmetric matrices.

Lemma 5.3. *Let A be a small-span Hermitian matrix. Then all entries of A have absolute value less than 2.5, and all off diagonal entries have absolute value less than 2.*

Proof. Let a be a diagonal entry in A . Then since the matrix (a) has a as an eigenvalue, interlacing shows that A has an eigenvalue with modulus at least $|a|$. Our restriction on the eigenvalues of A shows that $|a| < 2.5$.

Let b be an off-diagonal entry of A . Then deleting the other rows and columns gives a submatrix of the shape

$$\begin{pmatrix} a & b \\ \bar{b} & c \end{pmatrix}.$$

By repeated use of Corollary 5.2, this submatrix must have span less than 4, giving $\sqrt{(a-c)^2 + 4|b|^2} < 4$. This implies $|b| < 2$. ■

In order to obtain our results, we use a certain amount of computation. By Corollary 5.2, if A is a small-span matrix then so is any principal submatrix of A . Hence, to compute small-span matrices we can start by creating a list of all 1×1 small-span matrices, then for each matrix in the list we consider all of its supergraphs and add to our list any that have small-span. The list is then pruned with the goal of having at most one representative for each equivalence class. Since there is no canonical form in our equivalence class, we can only prune our list to some limited extent. We can repeat this growing process until all small-span matrices of the desired size are obtained. The algorithm we use is essentially the same as the one described in [23], with modifications to deal with irrational elements. Up to equivalence, we compute all small-span \mathcal{O}_K -matrices up to degree 8, and in doing so, we also compute Hermitian matrices whose eigenvalues satisfy the small-span condition but whose characteristic polynomial does not have integer

coefficients. As it turns out, these do not cause a problem and we will see that for $n > 6$, an $n \times n$ matrix whose eigenvalues satisfy the small-span condition also has an integer characteristic polynomial.

To make our computation more efficient we can bound the number of nonzero entries in a row of a small-span matrix. The amount of computation required to prove this lemma varies according to the ring over which we are working. The ring $\mathbb{Z}[\omega]$ requires the most work.

Lemma 5.4. *Let A be a small-span Hermitian $\mathbb{Z}[\omega]$ -matrix with all eigenvalues in the interval $[-2, 2.5)$. Then each row of A has at most 4 nonzero entries.*

Proof. First, we compute a list of all small-span $\mathbb{Z}[\omega]$ -graphs up to degree 6. This is done by exhaustively growing from 1×1 small-span matrices (a) where $a \in \mathbb{Z}[\omega]$ is an element whose absolute value is less than 2.5. We find by inspection that there are no small-span $\mathbb{Z}[\omega]$ -graphs of degree 6 that contain a vertex of degree greater than 4. Now suppose that there exists a small-span $\mathbb{Z}[\omega]$ -graph G on at least 7 vertices that has vertex of degree more than 4. Deleting vertices appropriately, we obtain a subgraph H on 6 vertices that has a vertex of degree 5. By Corollary 5.2, H has small-span. But we see that H is not on our computed list. Therefore, our supposition must be false. ■

It suffices to grow up to degree 5 for small-span R -matrices where $R \neq \mathbb{Z}[\omega]$ is a quadratic integer ring.

Lemma 5.5. *Let $R \neq \mathbb{Z}[\omega]$ be a quadratic integer ring and let A be a small-span Hermitian R -matrix with all eigenvalues in the interval $[-2, 2.5)$. Then each row of A has at most 3 nonzero entries.*

Proof. Same as the proof of Lemma 5.4, where each quadratic integer ring R is considered separately and the list of R -graphs only goes up to degree 5. ■

We can restrict our consideration to d in the set $\{-11, -7, -3, -2, -1, 2, 3, 5, 6\}$, since, for other d , there are no irrational elements of $\mathcal{O}_{\mathbb{Q}(\sqrt{d})}$ having absolute value small enough to satisfy Lemma 5.3. Hence, for the d not in this set, all small-span $\mathcal{O}_{\mathbb{Q}(\sqrt{d})}$ -matrices are \mathbb{Z} -matrices, which have already been classified.

Now, each 1×1 small-span matrix is equivalent to the 1×1 matrix (a) where $a \in \mathcal{O}_{\mathbb{Q}(\sqrt{d})}$ is real and $|a| < 2.5$. Moreover, for $d = 6$ and $n \geq 2$, all indecomposable $n \times n$ small-span matrices are \mathbb{Z} -matrices. Therefore, over quadratic integer rings $\mathcal{O}_{\mathbb{Q}(\sqrt{d})}$ for

5. Small-Span Hermitian Matrices over Quadratic Integer Rings

There are seven maximal indecomposable 4×4 examples:

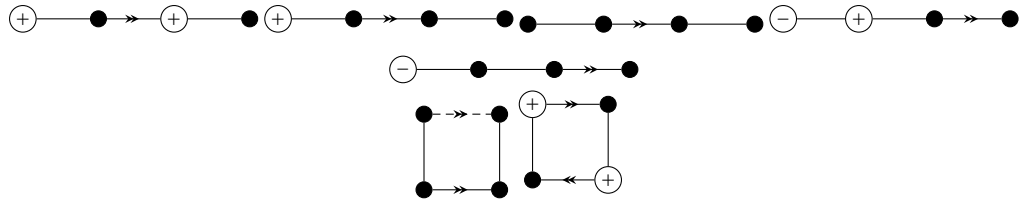

There are eight maximal indecomposable 5×5 examples:

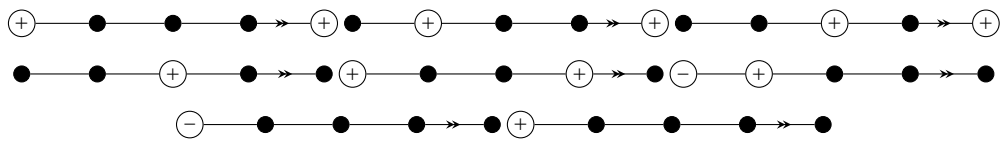

There are four maximal indecomposable 6×6 examples:

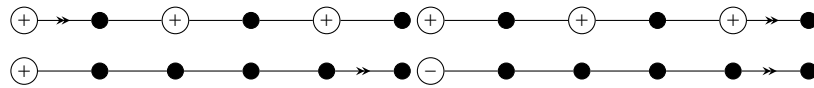

There are two maximal indecomposable 7×7 examples:

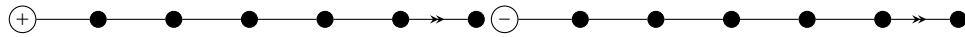

There are two maximal indecomposable 8×8 examples:

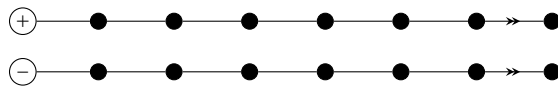

For $R = \mathbb{Z}[1/2 + \sqrt{-7}/2]$

There are two maximal indecomposable 2×2 examples:



There are six maximal indecomposable 3×3 examples:

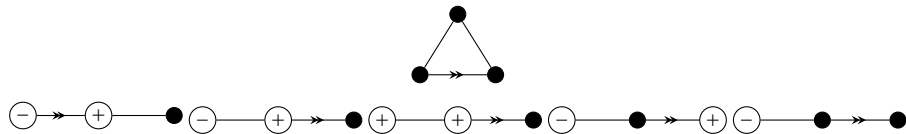

There are seven maximal indecomposable 4×4 examples:

5. Small-Span Hermitian Matrices over Quadratic Integer Rings

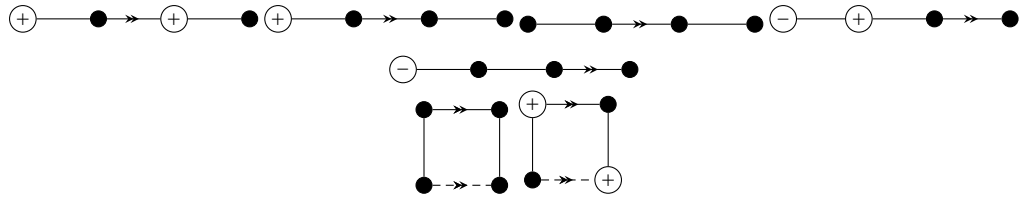

There are eight maximal indecomposable 5×5 examples:

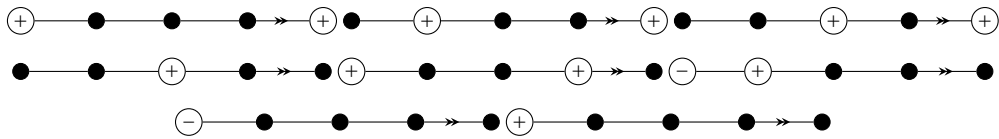

There are four maximal indecomposable 6×6 examples:

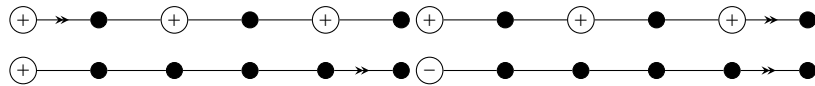

There are two maximal indecomposable 7×7 examples:



There are two maximal indecomposable 8×8 examples:

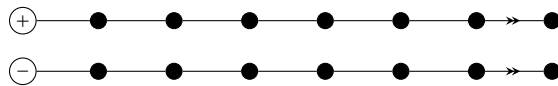

For $R = \mathbb{Z}[i]$

There are two maximal indecomposable 2×2 examples:

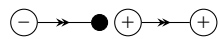

There are eight maximal indecomposable 3×3 examples:

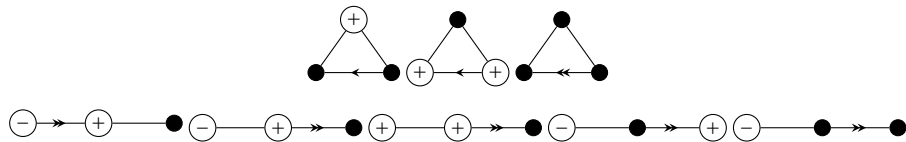

There are sixteen maximal indecomposable 4×4 examples:

5. Small-Span Hermitian Matrices over Quadratic Integer Rings

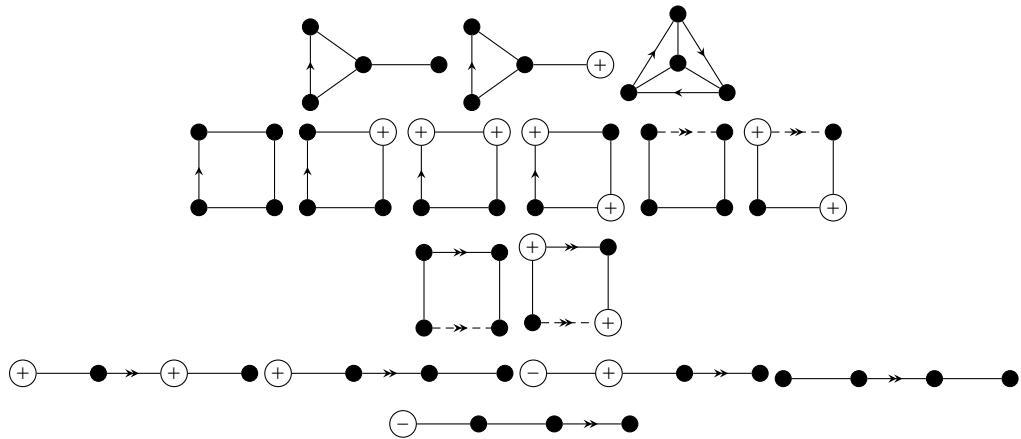

There are ten maximal indecomposable 5×5 examples:

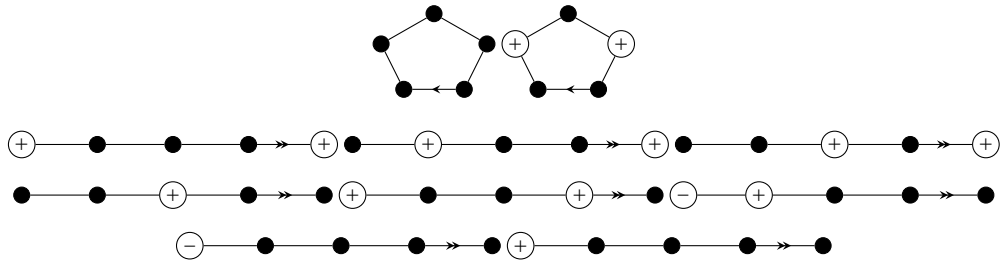

There are six maximal indecomposable 6×6 examples:

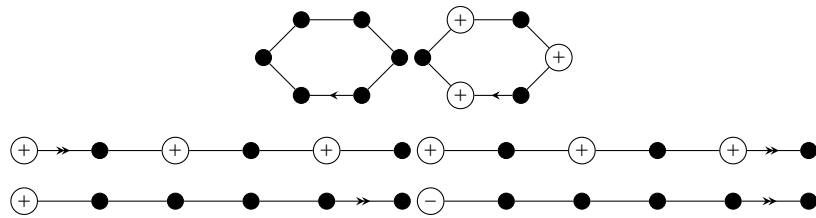

There are three maximal indecomposable 7×7 examples:

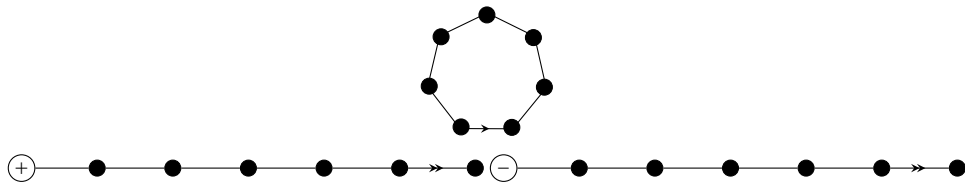

There are three maximal indecomposable 8×8 examples:

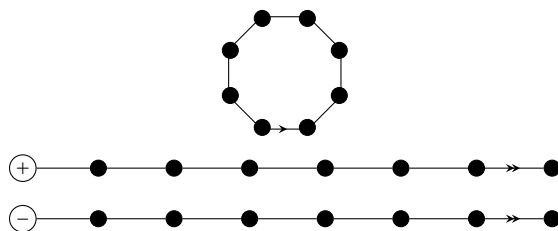

5. Small-Span Hermitian Matrices over Quadratic Integer Rings

For $R = \mathbb{Z}[\omega]$

There are two maximal indecomposable 2×2 examples:



There are three maximal indecomposable 3×3 examples:

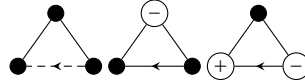

There are ten maximal indecomposable 4×4 examples:

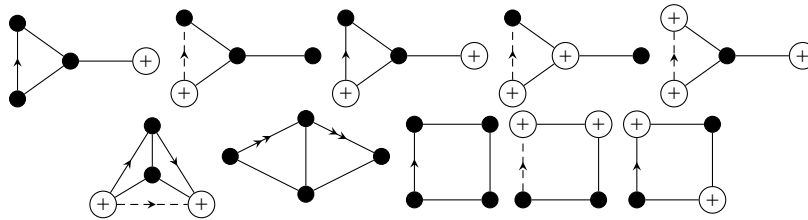

There are nine maximal indecomposable 5×5 examples:

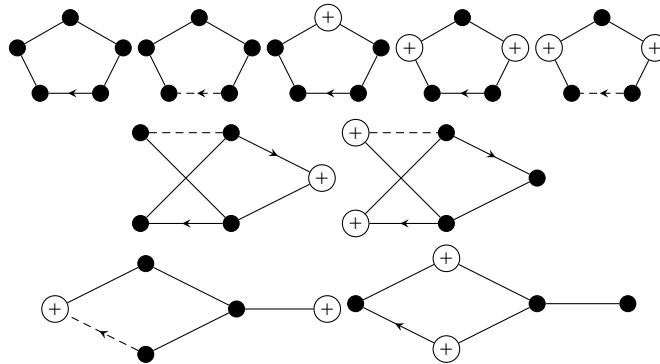

There are fourteen maximal indecomposable 6×6 examples:

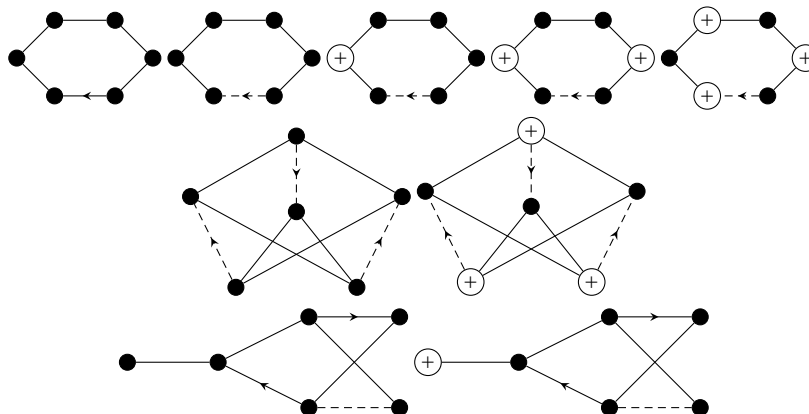

5. Small-Span Hermitian Matrices over Quadratic Integer Rings

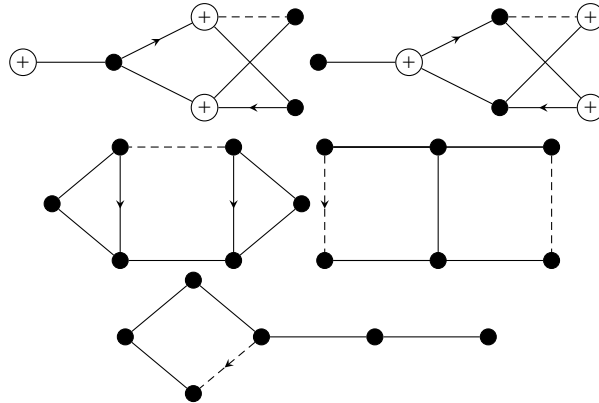

There are two maximal indecomposable 7×7 examples:

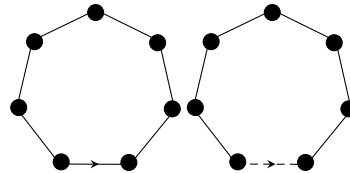

There are three maximal indecomposable 8×8 examples:

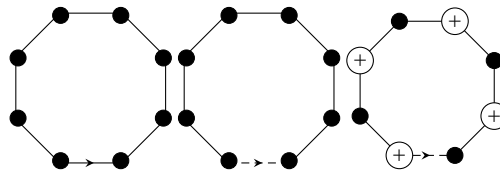

n	d							
	-11	-7	-3	-2	-1	2	3	5
2	2	2	2	4	2	3	2	2
3	0	6	3	5	8	5	0	4
4	0	7	10	7	16	7	0	10
5	0	8	9	8	10	8	0	1
6	0	4	14	4	6	4	0	0
7	0	2	2	2	3	2	0	0
8	0	2	3	2	3	2	0	0

Table 5.1: The number of maximal small-span matrices, that are not equivalent to a \mathbb{Z} -matrix, of up to 8 rows for each d .

Observe from Table 5.1 that for $d \in \{-11, 3, 5\}$, each small-span $O_{\mathbb{Q}(\sqrt{d})}$ -matrix having more than 5 rows is equivalent to a \mathbb{Z} -matrix. We summarise other useful implications from our computations in the following lemma.

Lemma 5.6. *Let G be small-span $O_{\mathbb{Q}(\sqrt{a})}$ -graph on more than 6 vertices. Then G has the following properties:*

1. *Each edge-weight of G has absolute value less than 2;*
2. *Each charge of G has absolute value at most 1;*
3. *G contains no triangles with fewer than 2 charges;*
4. *If G has an edge-weight of absolute value greater than 1 then G contains no triangles;*
5. *No charged vertex is incident to an edge-weight having absolute value more than 1.*

5.3 Maximal small-span infinite families

Let K be a quadratic number field and let R be its ring of integers. We define a **template** \mathcal{T} to be a \mathbb{C} -graph that is not equivalent to a \mathbb{Z} -graph and whose edge-weights are all determined except for some irrational edge-weights $\pm\alpha$ where α is determined only up to its absolute square $a = \alpha\bar{\alpha}$. The pair (\mathcal{T}, R) is the set of all R -graphs where α is substituted by some element $\rho \in R$ where $\rho\bar{\rho} = a$. We say an R -graph G **has template** \mathcal{T} if G is equivalent to some graph in (\mathcal{T}, R) . In a template, an edge of weight 1 is drawn as _____ and for weight -1 we draw ----- . Let α_1 and α_2 denote irrational complex numbers whose absolute squares are 1 and 2 respectively. We draw edges of weight α_1 as ———> and $-\alpha_1$ as <----- . Similarly, we draw edges of weight $\pm\alpha_2$ as ———> and <----- . For our purposes, we will not need to draw any other types of edges. A vertex with charge 1 is drawn as \oplus and a vertex with charge -1 is drawn as \ominus . And if a vertex is uncharged, we simply draw \bullet . A template only makes sense as a graph over rings that have irrational elements having the required absolute squares. Using templates, we can simultaneously study small-span graphs over various quadratic integer rings.

In this section we study the two classes of infinite families of small-span matrices over quadratic integer rings. Namely, these are the infinite families of templates \mathcal{P}_n and \mathcal{Q}_n .

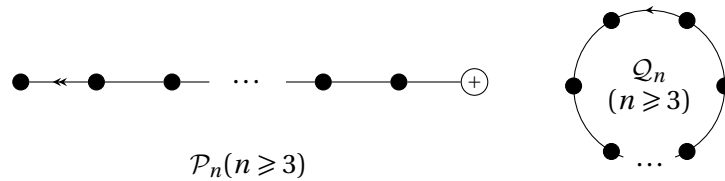

Our classification of small-span $O_{\mathbb{Q}(\sqrt{a})}$ -matrices uses the classification of cyclotomic $O_{\mathbb{Q}(\sqrt{a})}$ -matrices. Since small-span \mathbb{Z} -matrices have been classified, we can assume that

d is in the set $\{-11, -7, -3, -2, -1, 2, 3, 5, 6\}$. We can restrict d further. In the previous section we observed, from the computations, that on more than 5 rows there are no small-span matrices when d is $-11, 3, 5$ or 6 . Hence, we need only consider d from the set $\{-7, -3, -2, -1, 2\}$.

As discussed in the previous two chapters, cyclotomic $\mathcal{O}_{\mathbb{Q}(\sqrt{d})}$ -graphs have been classified for all d , with each classification being over a different set of rings. In these classifications, the maximal cyclotomic graphs belonging to an infinite family that are not \mathbb{Z} -graphs have one of three templates given in Figures 5.1, 5.2, and 5.3. We call a template \mathcal{T} cyclotomic (resp. small-span), if all the elements of $(\mathcal{T}, \mathcal{O}_{\mathbb{Q}(\sqrt{d})})$ are cyclotomic (resp. have small-span) for all d that make sense with \mathcal{T} . (E.g., the family of templates \mathcal{T}_{2k} in Figure 5.1 only make sense with $\mathcal{O}_{\mathbb{Q}(\sqrt{d})}$ when $d = -1$ or $d = -3$.) More generally, we say a template \mathcal{T} has property \mathfrak{P} if all $\mathcal{O}_{\mathbb{Q}(\sqrt{d})}$ -graphs in $(\mathcal{T}, \mathcal{O}_{\mathbb{Q}(\sqrt{d})})$ have property \mathfrak{P} for all appropriate d . Warning: two graphs that have the same template do not necessarily have the same eigenvalues.

In Figures 5.1, 5.2, and 5.3, we have three infinite families of cyclotomic templates \mathcal{T}_{2k} , \mathcal{C}_{2k} , and \mathcal{C}_{2k+1} . The sets (\mathcal{T}_{2k}, R) , (\mathcal{C}_{2k}, S) , (\mathcal{C}'_{2k}, S) and (\mathcal{C}_{2k+1}, S) are sets of maximal cyclotomic graphs where $R = \mathcal{O}_{\mathbb{Q}(\sqrt{d})}$ for $d = -1$ or $d = -3$, and $S = \mathcal{O}_{\mathbb{Q}(\sqrt{d})}$ for $d \in \{-7, -2, -1, 2\}$. The set (\mathcal{C}'_{2k}, S) is equal to the set (\mathcal{C}_{2k}, S) unless $S = \mathcal{O}_{\mathbb{Q}(\sqrt{-7})}$. The arguments regarding the templates \mathcal{C}'_{2k} are very similar to those of \mathcal{C}_{2k} and hence we will ignore the templates \mathcal{C}'_{2k} for the remainder of the chapter.

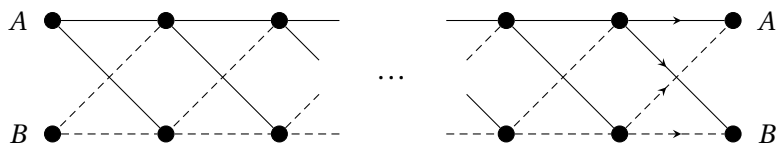

Figure 5.1: The infinite family \mathcal{T}_{2k} of $2k$ -vertex maximal connected cyclotomic templates. (The two copies of vertices A and B should be identified to give a toral tessellation.)

All of the eigenvalues of the maximal connected cyclotomic graphs, in the sets (\mathcal{T}_{2k}, R) , (\mathcal{C}_{2k}, S) , and (\mathcal{C}_{2k+1}, S) , are equal to ± 2 with at least one pair of eigenvalues having opposite signs. Hence each of these graphs has span equal to 4. We want to find small-span graphs contained inside these maximal connected cyclotomic templates. We look for subgraphs that have span equal to 4. This way, we can recognise that a subgraph does not have small-span if it contains one of these subgraphs. In Figure 5.4 we list 4 infinite families of cyclotomic sub-templates having span equal to 4.

We can show that the sub-templates $\mathcal{X}_n^{(1)}$, $\mathcal{X}_n^{(2)}$, $\mathcal{X}_n^{(3)}$, and $\mathcal{X}_{s,t}^{(4)}$ in Figure 5.4 have span

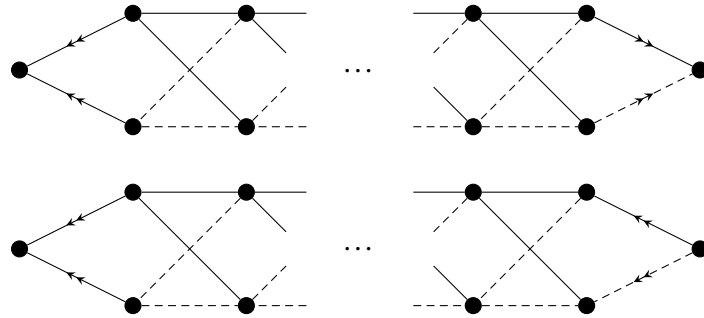

Figure 5.2: The infinite family of $2k$ -vertex maximal connected cyclotomic templates C_{2k} and C'_{2k} (respectively) for $k \geq 2$.

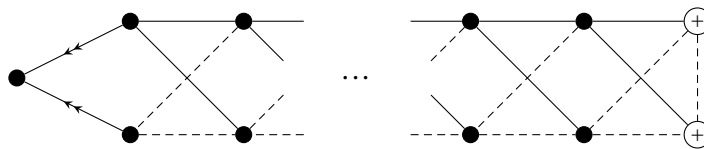

Figure 5.3: The infinite family of $(2k + 1)$ -vertex maximal connected cyclotomic templates C_{2k+1} for $k \geq 1$.

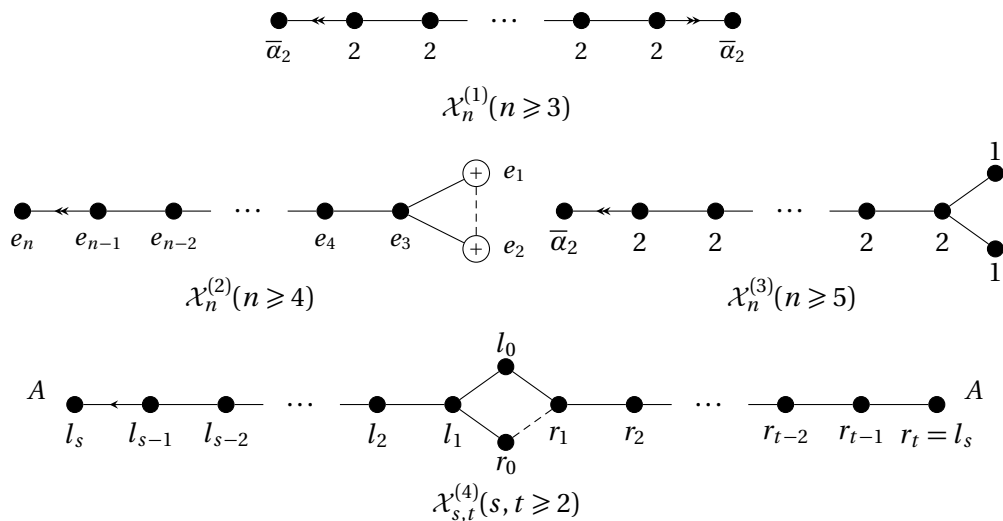

Figure 5.4: Cyclotomic templates having span equal to 4. In the first three templates, the subscript denotes the number of vertices. The last template has $s + t + 1$ vertices and the two copies of the vertex A should be identified.

equal to 4 by simply pointing out the eigenvectors corresponding to the eigenvalues ± 2 . For each $\mathcal{O}_{\mathbb{Q}(\sqrt{d})}$ -graph in $(\mathcal{X}_n^{(1)}, \mathcal{O}_{\mathbb{Q}(\sqrt{d})})$ or $(\mathcal{X}_n^{(3)}, \mathcal{O}_{\mathbb{Q}(\sqrt{d})})$, we use α_2 to label the edge-weights of absolute square 2. The numbers beneath the vertices of $\mathcal{X}_n^{(1)}$ and $\mathcal{X}_n^{(3)}$ in Figure 5.4 correspond to entries of an eigenvector having associated eigenvalue 2 and since these two templates are bipartite, they also have an eigenvalue -2 . The entries of the eigenvectors of $\mathcal{X}_n^{(2)}$ are represented by the e_j ; the eigenvector associated to 2 has $e_1 = 1$, $e_2 = -1$, and $e_j = 0$ for $j \in \{3, \dots, n\}$. For the eigenvalue -2 we have $e_1 = e_2 = 1$, $e_j = (-1)^j$ for $j \in \{3, \dots, n-1\}$, and $e_n = (-1)^n \cdot \alpha_2$.

For the graph $\mathcal{X}_{s,t}^{(4)}$, we use α_1 to label the edge-weights of absolute square 1. For the eigenvalue

-2 : for $j \in \{1, \dots, s-1\}$, set

$$l_j = (-1)^{s-j}(1 + \alpha_1), \quad r_j = (-1)^{t-j}(1 + \bar{\alpha}_1), \quad \text{and} \quad l_s = r_t = 1 + \bar{\alpha}_1.$$

If $s + t$ is even, set

$$l_0 = (-1)^s \left(1 + \frac{\alpha_1 + \bar{\alpha}_1}{2} \right) \quad \text{and} \quad r_0 = (-1)^s \frac{\alpha_1 - \bar{\alpha}_1}{2}.$$

Otherwise set

$$l_0 = (-1)^s \frac{\alpha_1 - \bar{\alpha}_1}{2} \quad \text{and} \quad r_0 = (-1)^s \left(1 + \frac{\alpha_1 + \bar{\alpha}_1}{2} \right).$$

2 : set

$$l_1 = \dots = l_{s-1} = 1 + \alpha_1, \quad r_1 = \dots = r_t = l_s = 1 + \bar{\alpha}_1, \quad l_0 = 1 + \frac{\alpha_1 + \bar{\alpha}_1}{2}, \quad \text{and} \quad r_0 = \frac{\alpha_1 - \bar{\alpha}_1}{2}.$$

The \mathbb{Z} -graph $X_4^{(5)}$ in Figure 5.5 also has span equal to 4.

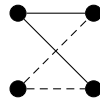

Figure 5.5: The \mathbb{Z} -graph $X_4^{(5)}$.

In the next two lemmata we show that any small-span sub-template of \mathcal{C}_{2k} , \mathcal{C}_{2k+1} , or \mathcal{T}_{2k} is a sub-template of either \mathcal{P}_n or \mathcal{Q}_n .

Lemma 5.7. *The template \mathcal{P}_n has small-span for all $n \geq 3$. Any connected small-span sub-template of either \mathcal{C}_{2k} or \mathcal{C}_{2k+1} is contained in \mathcal{P}_n for some n .*

Here

$$S(n) = \frac{1}{n} (1 - (-1)^n (\alpha_1 + \bar{\alpha}_1)) - \sum_{k=2}^n \frac{1}{k(k-1)}.$$

Hence the determinant of this matrix is

$$2 - (-1)^n (\alpha_1 + \bar{\alpha}_1).$$

Since the absolute square of α_1 is 1, the absolute value of the real part of α_1 is at most 1, and so the determinant is nonzero for all n . Therefore \mathcal{Q}_n is small-span.

By Corollary 5.2, no small-span template can contain $\mathcal{X}_{t,s}^{(4)}$ (see Figure 5.4) for all $s, t \geq 2$. Moreover, any subgraph of \mathcal{T}_{2k} obtained by deleting two vertices that have the same neighbourhood is a \mathbb{Z} -graph and hence not a template. With these two restrictions on the subgraphs of \mathcal{T}_{2k} , we are done. ■

Using the classification of cyclotomic matrices over quadratic integer rings, in the next theorem we classify cyclotomic small-span $\mathcal{O}_{\mathbb{Q}(\sqrt{d})}$ -matrices.

Theorem 5.9. *Let \mathcal{T} be a connected cyclotomic small-span template on more than 6 vertices. Then \mathcal{T} is contained in either \mathcal{P}_n or \mathcal{Q}_n for some n .*

Proof. We can readily check the subgraphs of sporadic cyclotomic graphs of over quadratic integer rings (see the classifications in Chapter 3, Chapter 4, and [40]) that are not equivalent to a \mathbb{Z} -graph, to find that no such subgraph on more than 6 vertices has small-span. The theorem then follows from Lemma 5.7 and Lemma 5.8. ■

Before completing the classification of small-span $\mathcal{O}_{\mathbb{Q}(\sqrt{d})}$ -matrices, we first state some lemmata.

Lemma 5.10. [23, Lemma 2] *Let G be a connected graph and let u and v be vertices of G such that the distance from u to v is maximal. Then the subgraph induced by removing u (and its incident edges) is connected.*

Lemma 5.11. [5, Theorem 2.2] *Let G be a path whose edge-weights α satisfy $|\alpha| = 1$. Then G is strongly equivalent to a simple path.*

We are now ready to prove the following theorem.

Theorem 5.12. *Let \mathcal{T} be a small-span template on more than 8 vertices. Then \mathcal{T} is cyclotomic.*

Proof. Let \mathcal{T}' be a counterexample on the minimal number of vertices possible. Then \mathcal{T}' has at least 9 vertices and it follows from the minimality of \mathcal{T}' that any proper sub-template of \mathcal{T}' must have all its eigenvalues in the interval $[-2, 2]$, but if \mathcal{T}' does not have any proper sub-templates, i.e., if all its subgraphs are equivalent to \mathbb{Z} -graphs, then \mathcal{T}' must be a cycle and its subpaths need not have all their eigenvalues in $[-2, 2]$. Pick vertices u and v as far apart as possible in \mathcal{T}' . By Lemma 5.10, deleting either u or v leaves a connected subgraph on at least 8 vertices. If the subgraph G_u obtained by deleting u from \mathcal{T}' is equivalent to a \mathbb{Z} -graph then let $G = G_v$ be the subgraph obtained by deleting v , otherwise let $G = G_u$. If G is a template, then by Theorem 5.9, either G is equivalent to \mathcal{Q}_n for some n or G is equivalent to a connected subgraph of \mathcal{P}_n for some n . Otherwise, if G is equivalent to a \mathbb{Z} -graph, \mathcal{T}' must be a cycle and each irrational edge-weight α must satisfy $|\alpha| = 1$. Moreover, by Lemma 5.6, we have that every edge-weight of \mathcal{T}' must have absolute value equal to 1. First we deal with the case where G is equivalent to a \mathbb{Z} -graph.

Case 1. Suppose G is equivalent to a \mathbb{Z} -graph. Then, by above, \mathcal{T}' is a cycle whose edge-weights all have absolute value 1. Let C be a cycle on $n \geq 9$ vertices v_0, v_1, \dots, v_{n-1} such that v_j is adjacent to v_{j+1} with subscripts reduced modulo n . Let each vertex v_j of C have charge $c_j \in \{-1, 0, 1\}$ and let each edge-weight have absolute value 1. Now, if C is small-span then each induced subpath of C is small-span. Hence, C is small-span only if each subpath $v_k v_{k+1} \dots v_{k+n-2}$ is small-span for all k where the subscripts are reduced modulo n . Since we are working up to equivalence, by Lemma 5.11, we can assume that all edges in these paths have weight 1. We have computed all small-span $\mathbb{Z}[i]$ and $\mathbb{Z}[\omega]$ -cycles on up to 12 vertices to find that the ones on more than 8 vertices have \mathcal{Q}_n (for some n) as a template. Using Lemma 5.1 and computing all small-span \mathbb{Z} -paths on 12 vertices, one can check that C is small-span only if $c_j = 0$ for all $j \in \{0, \dots, n-1\}$. Therefore, \mathcal{T}' must be uncharged. Hence \mathcal{T}' is equivalent to \mathcal{Q}_n for some n (see Lemma 3.16). This contradicts \mathcal{T}' being non-cyclotomic. Note that we cannot do better than 8 vertices since the following non-cyclotomic $\mathbb{Z}[\omega]$ -cycle \mathcal{C}_8 is small-span:

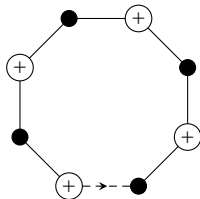

where the irrational edge-weight is $-\omega$.

Now we have two remaining cases to consider: the case where G is contained in \mathcal{P}_n and the case where G is equivalent to \mathcal{Q}_n for some n . In each case, by Lemma 5.6, we can exclude the possibility that G contains a triangle having fewer than 2 charged vertices. And similarly, by Lemma 5.6, we need only consider charges from the set $\{-1, 0, 1\}$. Moreover, we can exclude any graph equivalent to $X_5^{(6)}$, $X_5^{(7)}$, $X_5^{(8)}$, or $X_8^{(9)}$ (see Figure 5.6) as a subgraph of a small-span graph since these graphs have span at least 4.

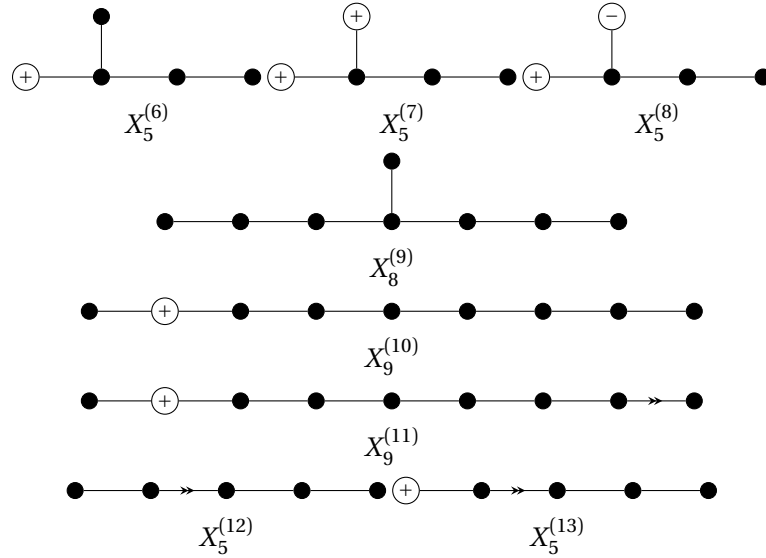

Figure 5.6: The \mathbb{Z} -graphs $X_5^{(6)}$, $X_5^{(7)}$, $X_5^{(8)}$, $X_8^{(9)}$, $X_9^{(10)}$, $X_9^{(11)}$, $X_5^{(12)}$, and $X_5^{(13)}$ which all have span greater than or equal to 4.

Case 2. Suppose G is equivalent to a sub-template of \mathcal{P}_n for some n . In this case \mathcal{T}' cannot be a cycle for, if it were, it would have a sub-template on more than 6 vertices that is not equivalent to a subgraph of either \mathcal{P}_n or \mathcal{Q}_n contradicting Theorem 5.9. By Lemma 5.6, a charged vertex cannot be incident to an edge-weight of absolute value greater than 1 and \mathcal{T}' does not contain any triangles. Moreover, since we have excluded $X_5^{(6)}$, $X_5^{(7)}$, and $X_5^{(8)}$, no leaf (a vertex having only one neighbour) can share its neighbourhood with a charged leaf.

Since it is equivalent to a subgraph of \mathcal{P}_n , we have that G is a path. Recall that we obtained G by deleting either u or v which are vertices at the maximal distance from one another. Label the vertices of G by v_0, v_1, \dots, v_{r-1} where v_{j-1} is adjacent to v_j for $j \in \{1, \dots, r-1\}$. Then we can obtain \mathcal{T}' from G by attaching a vertex to one of the vertices v_0, v_1, v_{r-2} , or v_{r-1} . Thus, in order for \mathcal{T}' not to contain a subgraph equivalent to $X_5^{(6)}$, $X_5^{(7)}$, $X_5^{(8)}$, $X_9^{(10)}$, $X_9^{(11)}$, $X_5^{(12)}$, $X_5^{(13)}$, $\mathcal{X}_k^{(1)}$, or $\mathcal{X}_k^{(3)}$, the template \mathcal{T}' must be equivalent to a

sub-template of either $\mathcal{X}_k^{(1)}$, $\mathcal{X}_k^{(3)}$, or \mathcal{P}_k for some k . Since each of these templates are cyclotomic, we have established a contradiction.

Case 3. Suppose G is equivalent to \mathcal{Q}_n for some n . Since we have excluded graphs equivalent to $\mathcal{X}_{t,s}^{(4)}$, $X_5^{(6)}$, and $X_8^{(9)}$ as subgraphs, and triangles with fewer than two charges are forbidden, there do not exist any possible small-span supergraphs \mathcal{T}' having G as a subgraph. We are done. \blacksquare

5.4 Missing small-span polynomials

Finally, we turn our attention to the question of which polynomials appear as minimal polynomials of small-span matrices. We define a **cosine polynomial** to be a monic integer polynomial having all its zeros contained in the interval $[-2, 2]$, and a **non-cosine polynomial** to be a monic totally real integer polynomial with at least one zero lying outside $[-2, 2]$. McKee [23] found six small-span polynomials of low degree that are not the minimal polynomial of any Hermitian \mathbb{Z} -matrix: three degree-6 cosine polynomials

$$x^6 - x^5 - 6x^4 + 6x^3 + 8x^2 - 8x + 1,$$

$$x^6 - 7x^4 + 14x^2 - 7,$$

$$x^6 - 6x^4 + 9x^2 - 3,$$

and three degree-7 non-cosine polynomials

$$x^7 - x^6 - 7x^5 + 5x^4 + 15x^3 - 5x^2 - 10x - 1,$$

$$x^7 - 8x^5 + 19x^3 - 12x - 1,$$

$$x^7 - 2x^6 - 6x^5 + 11x^4 + 11x^3 - 17x^2 - 6x + 7.$$

Suppose a non-cosine integer polynomial of degree more than 8 is the minimal polynomial of a Hermitian R -matrix for some quadratic integer ring R . Then, by Theorem 5.12, it is the minimal polynomial of an integer symmetric matrix. In fact, by our computations, the above holds for irreducible non-cosine polynomials of degree more than 6, and we record this result as a corollary. Let $Q(x)$ be the characteristic polynomial of \mathfrak{C}_8 (from the proof of Theorem 5.12).

Corollary 5.13. *Let R be a quadratic integer ring and let $f(x) \neq \pm Q(x)$ be a non-cosine polynomial of degree more than 6. If f is the minimal polynomial of some Hermitian R -matrix then f is the minimal polynomial of some integer symmetric matrix.*

Hence, in particular, the three degree-7 non-cosine polynomials are not minimal polynomials of any Hermitian R -matrix for any quadratic integer ring R .

We do, however, find that two of the degree-6 cosine polynomials above are characteristic polynomials of Hermitian $\mathbb{Z}[\omega]$ -matrices. The graph

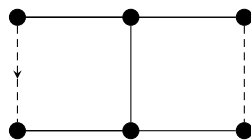

where $\alpha_1 = \omega$, has characteristic polynomial $x^6 - 7x^4 + 14x^2 - 7$; and the graphs \mathcal{Q}_6 and

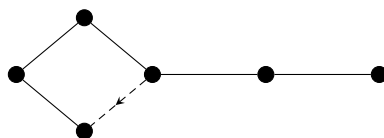

where $\alpha_1 = \omega$ in both, have characteristic polynomial $x^6 - 6x^4 + 9x^2 - 3$.

The polynomial $p(x) = x^6 - x^5 - 6x^4 + 6x^3 + 8x^2 - 8x + 1$ remains somewhat elusive as it is *not* the minimal polynomial of an Hermitian R -matrix for any quadratic integer ring R . For suppose that $p(x)$ is the minimal polynomial of some Hermitian R -matrix A . Then each eigenvalue of A is a zero of $p(x)$ [15, §11.6] and the minimal polynomial $p(x)$ divides the characteristic polynomial $\chi_A(x)$. Hence, since $p(x)$ is irreducible, $\chi_A(x)$ must be some power of $p(x)$. Therefore, we need to check that $p(x)$ is not the minimal polynomial of any $r \times r$ Hermitian R -matrix where 6 divides r . Both \mathcal{P}_n and \mathcal{Q}_n have span larger than the span of $p(x)$ for $n \geq 18$ and we have checked all possible matrices for $r = 6$ and 12.

Finally, we point out a matrix that comes close to having $p(x)$ as its minimal polynomial: the $\mathbb{Z}[\omega]$ -graph \mathcal{Q}_7 where $\alpha_1 = -\omega$, has as its characteristic polynomial the polynomial $(x + 1)(x^6 - x^5 - 6x^4 + 6x^3 + 8x^2 - 8x + 1)$.

Bibliography

- [1] BORWEIN, P., DOBROWOLSKI, E., AND MOSSINGHOFF, M. Lehmer's problem for polynomials with odd coefficients. *Annals of mathematics* 166, 2 (2007), 347–366. 13
- [2] BOURBAKI, N. *Lie groups and Lie algebras chapters 4-6*. Springer, 2002. 28
- [3] BOYD, D. W. Small Salem numbers. *Duke Mathematical Journal* 44, 2 (1977), 315–328. 9, 13, 35
- [4] BREUSCH, R. On the distribution of the roots of a polynomial with integral coefficients. *Proc. Amer. Math. Soc.* 2 (1951), 939–941. 3, 11
- [5] CAMERON, P., SEIDEL, J., AND TSARANOV, S. Signed graphs, root lattices, and Coxeter groups. *Journal of Algebra* 164 (1994), 173–209. 118
- [6] CAPPARELLI, S., DEL FRA, A., AND SCIÒ, C. On the span of polynomials with integer coefficients. *Math. Comp.* 79, 270 (2010), 967–981. 102
- [7] CAUCHY, A.-L. Sur l'équation à l'aide de laquelle on détermine les inégalités séculaires des mouvements des planètes. In *Oeuvres complètes, IIIième Série* (1829), Gauthier-Villars. 17
- [8] CVETKOVIĆ, D., DOOB, M., AND GUTMAN, I. On graphs whose spectral radius does not exceed $(2 + \sqrt{5})^{1/2}$. *Ars Combinatoria* 14 (1982), 225–239. 22
- [9] CVETKOVIĆ, D. AND ROWLINSON, P. The largest eigenvalue of a graph: A survey. *Linear and Multilinear Algebra* 28 (1990), 3–33. 12
- [10] DOBROWOLSKI, E. A note on integer symmetric matrices and Mahler's measure. *Canadian Mathematical Bulletin* 51, 1 (2008), 57–59. 13, 14
- [11] ESTES, D. R. Eigenvalues of symmetric integer matrices. *Journal of Number Theory* 42, 3 (1992), 292–296. 14
- [12] ESTES, D. R. AND GURALNICK, R. Minimal polynomials of integer symmetric matrices. *Linear algebra and its applications* 192 (1993), 83–99. 14, 103
- [13] FISK, S. A very short proof of Cauchy's interlace theorem for eigenvalues of Hermitian matrices. *Amer. Math. Monthly* 112, 2 (February 2005), 118. 17
- [14] GODSIL, C. AND ROYLE, G. *Algebraic Graph Theory*. Graduate Texts in Mathematics. New York: Springer, 2000. 20, 90
- [15] HARTLEY, B. AND HAWKES, T. O. *Rings, Modules and Linear Algebra*. Chapman and Hall/CRC, 1970. 122

Bibliography

- [16] HOFFMAN, A. J. Eigenvalues of graphs. In *Studies in Graph Theory* (Washington, 1975), D. R. Fulkerson, Ed., Mathematical Association of America, pp. 225–245. 14
- [17] HUMPHREYS, J. E. *Reflection Groups and Coxeter Groups*. Cambridge University Press, 1990. 93
- [18] HWANG, S.-G. Cauchy’s interlace theorem for eigenvalues of Hermitian matrices. *Amer. Math. Monthly* 111 (February 2004), 157–159. 17
- [19] KRONECKER, L. Zwei Sätze über Gleichungen mit ganzzahligen Coefficienten. *J. Reine Angew. Math.* 53 (1857), 173–175. 10
- [20] LEHMER, D. H. Factorization of certain cyclotomic functions. *Annals of mathematics* 34, 3 (1933), 461–479. 3, 10
- [21] LEHRER, G. I. AND TAYLOR, D. E. *Unitary reflection groups*. No. 20 in Australian Mathematical Society Lecture Series. Cambridge University Press, Cambridge, UK, New York, 2009. 45
- [22] MAHLER, K. On some inequalities for polynomials in several variables. *J. London Math. Soc.* 37 (1962), 341–344. 9
- [23] MCKEE, J. Small-span characteristic polynomials of integer symmetric matrices. In *Algorithmic Number Theory* (2010), G. Hanrot, F. Morain, and E. Thomé, Eds., vol. 6197 of *Lecture Notes in Comput. Sci.*, Springer–Verlag. 3, 14, 102, 103, 104, 118, 121
- [24] MCKEE, J. AND SMYTH, C. Salem numbers, Pisot numbers, Mahler measure, and graphs. *Experimental Mathematics* 14, 2 (2005), 211–229. 12, 35, 36, 37, 38
- [25] MCKEE, J. AND SMYTH, C. Integer symmetric matrices having all their eigenvalues in the interval $[-2, 2]$. *Journal of Algebra* 317 (2007), 260–290. 13, 40, 45, 79
- [26] MCKEE, J. AND SMYTH, C. Integer symmetric matrices of small spectral radius and small Mahler measure. *International Mathematics Research Notices* (2011). 3, 13, 40, 72, 74, 100
- [27] McMULLEN, C. T. Coxeter groups, Salem numbers and the Hilbert metric. *Publications Mathématiques de L’IHÉS* 95, 1 (2001), 151–183. 30
- [28] MOSSINGHOFF, M. List of small Salem numbers. <http://www.cecm.sfu.ca/~mjm/Lehmer/lists/SalemList.html>. 13
- [29] PARI/GP. version 2.3.4 [online]. <http://pari.math.u-bordeaux.fr>, 2011. 92
- [30] PETROVIĆ, M. M. On graphs whose spectral spread does not exceed 4. *Publications de l’Institut Mathématique (Beograd)* 34, 48 (1983), 169–175. 103
- [31] ROBINSON, R. M. Algebraic equations with span less than 4. *Mathematics of Computation* 18, 88 (1964), pp. 547–559. 102
- [32] SALEM, R. A remarkable class of algebraic integers. proof of a conjecture of vija-yaraghavan. *Duke Mathematical Journal* (1944). 9

Bibliography

- [33] SALEM, R. Power series with integral coefficients. *Duke Mathematical Journal* 12 (1945), 153–172. 9
- [34] SCHUR, I. Über die Verteilung der Wurzeln bei gewissen algebraischen Gleichungen mit ganzzahligen Koeffizienten. *Mathematische Zeitschrift* 1, 4 (1918), 377–402. 102
- [35] SIEGEL, C. L. Algebraic integers whose conjugates lie in the unit circle. *Duke Mathematical Journal* 11 (1944), 597–602. 9
- [36] SMITH, J. H. Some properties of the spectrum of a graph. In *Combinatorial Structures and their Applications (Proc. Calgary Internat. Conf., Calgary, Alta., 1969)*. Gordon and Breach, New York, 1970, pp. 403–406. 12, 19, 20
- [37] SMYTH, C. The Mahler measure of algebraic numbers: a survey. In *Number Theory and Polynomials* (2008), J. McKee and C. Smyth, Eds., London Mathematical Society Lecture Note Series, Cambridge University Press. 10
- [38] SMYTH, C. J. On the product of the conjugates outside the unit circle of an algebraic integer. *Bull. London Math. Soc.* 3 (1971), 169–175. 3, 11
- [39] TAYLOR, G. *Cyclotomic matrices and graphs*. Ph.D. thesis, Edinburgh, 2009. 40
- [40] TAYLOR, G. Cyclotomic matrices and graphs over the ring of integers of some imaginary quadratic fields. *Journal of Algebra* 331 (2011), 523–545. 40, 118
- [41] TAYLOR, G. Lehmer’s conjecture for matrices over the ring of integers of some imaginary quadratic fields. *Journal of Number Theory* 132, 4 (April 2012), 590–607. 40